

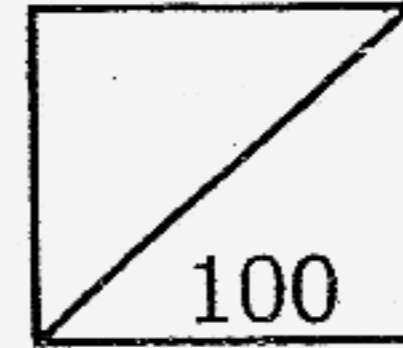

Rosyth School
Second Semestral Assessment for 2007
SCIENCE
Primary 3



Name: _____

Total
Marks:

Class: Pr _____

Register No. _____

Duration: 1 h 30 min

Date: 1 November 2007

Parent's Signature: _____

Instructions to Pupils:

1. Do not open the booklets until you are told to do so.
2. Follow all instructions carefully.
3. This paper consists of 2 booklets, Booklet A and Booklet B.
4. For questions 1 to 30 in Booklet A, shade the correct ovals on the Optical Answer Sheet (OAS) provided using a 2B pencil.
5. For questions 31 to 46, give your answers in the spaces given in the Booklet B.

	Maximum	Marks Obtained
Booklet A	60 marks	
Booklet B	40 marks	
Total	100 marks	

* This booklet consists of 12 pages . (Pg. 1 to 12)

This paper is not to be reproduced in part or whole without the permission of the Principal.

Part I (60 MARKS)

For each question from 1 to 30, four options are given. One of them is the correct answer. Make your choice (1, 2, 3 or 4). **Shade the correct oval (1, 2, 3 or 4) on the Optical Answer Sheet.**

1. Look at the classification chart below.

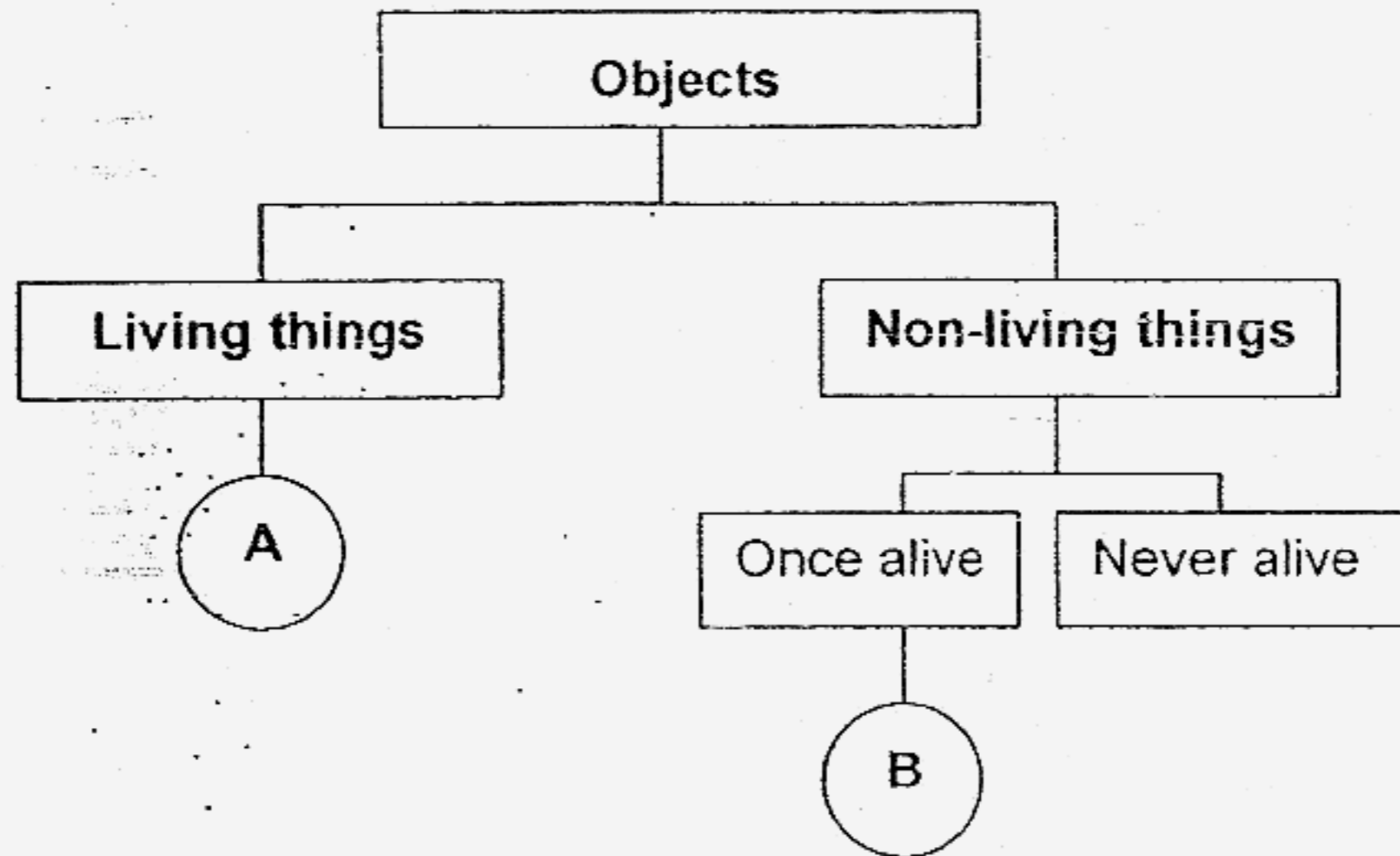

Which of the following represents A and B correctly?

	A	B
(1)	Bread mould	Leather sofa
(2)	Guinea pig	Plastic bag
(3)	Horseshoe magnet	Wooden stool
(4)	Apple pie	Caterpillar

2. The living things shown below are grouped based on the type of food they eat.

Herbivores	Carnivores	Omnivores
Butterfly	Giraffe	Duck
Deer	Tiger	Pig
Bee	Dragonfly	Chicken

Identify the animal that has been classified incorrectly?

- | | |
|-------------|---------------|
| (1) Bee | (2) Pig |
| (3) Giraffe | (4) Dragonfly |

3. Study the classification chart below.

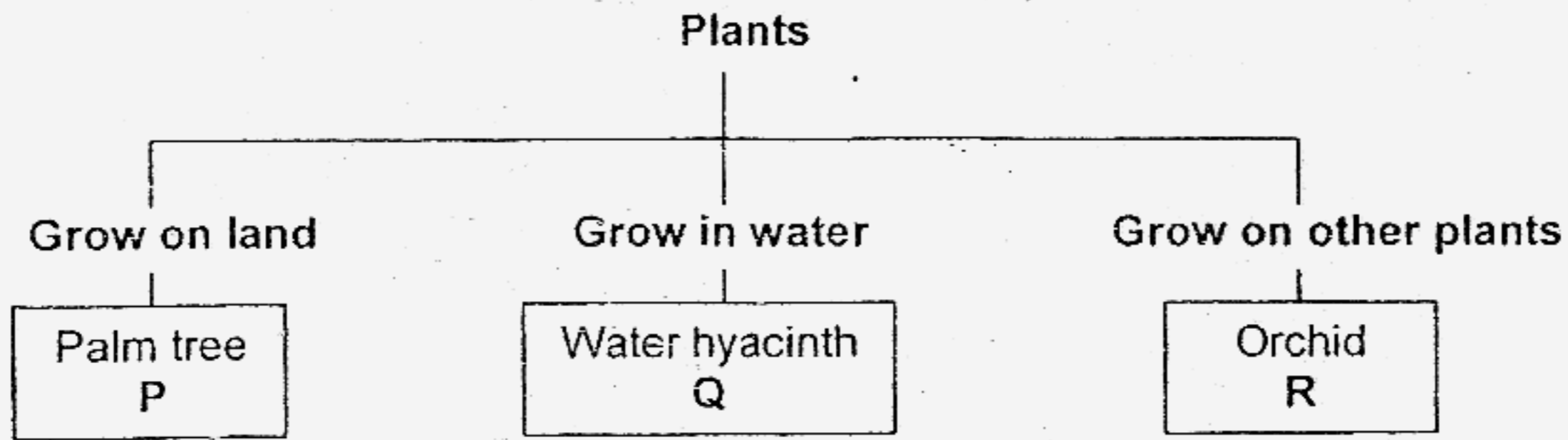

Which one of the following sets of plants can be represented by P, Q and R?

	P	Q	R
(1)	Cactus	Allamanda	Angsana
(2)	Cattail	Water lettuce	Stag's horn fern
(3)	Lantana	Water lily	Rambutan
(4)	Morning glory	Hydrilla	Bird's nest fern

4. Carolyn grew a small plant in a glass container. She set up the container as shown below.

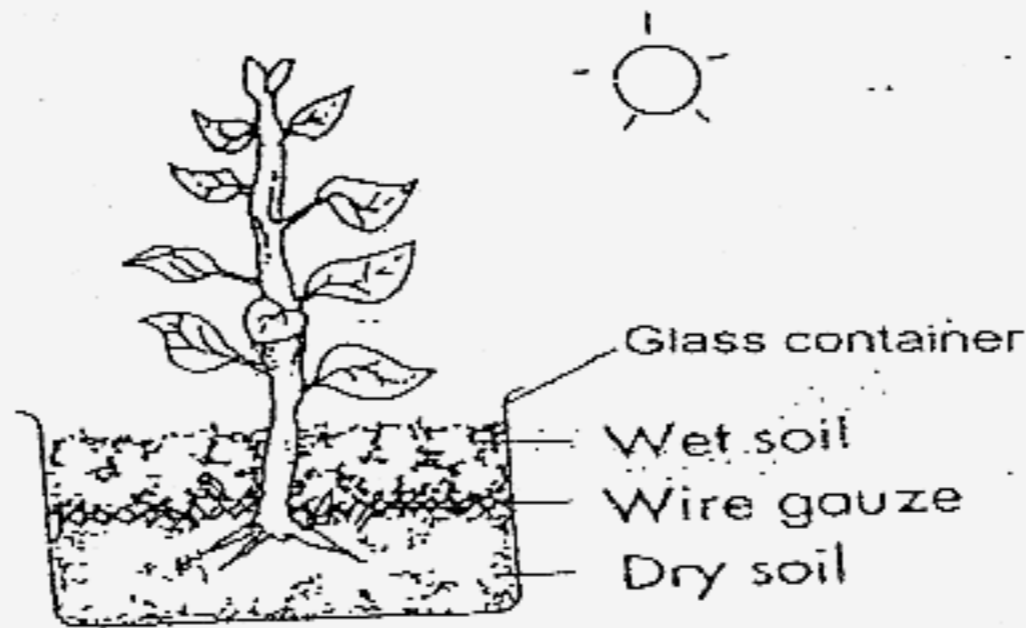

After a few days, she observed that the roots of the plant had shown some movement as shown below.

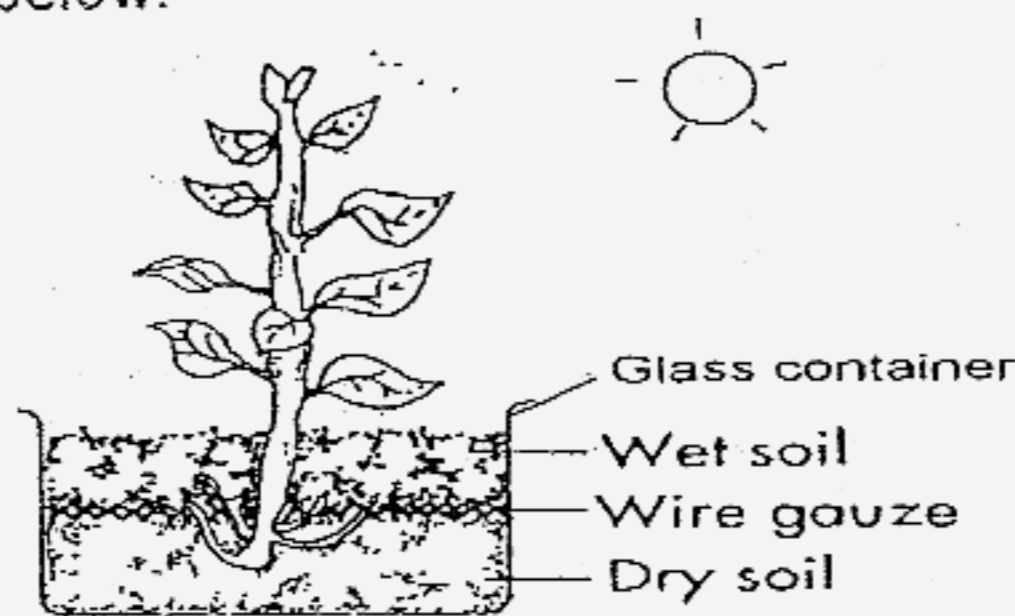

What does this tell us about the characteristics of plants?

- (1) All parts of plants always move upwards.
- (2) Roots respond towards water and light.
- (3) Roots move in search of water.
- (4) Roots move up to receive light.

5. Which of the following will not make their own food even when air, water and sunlight are present?

- A: Button mushroom
- B: Maidenhair fern
- C: Seaweed
- D: Toadstool
- E: Jew's ears

- (1) A, B and C only (2) A, D and E only
 (3) B, C and D only (4) C, D and E only

6. Ivan found an animal in a garden. He wanted to confirm if the animal found was an insect. Which of the following characteristics should he observe?

- A: The number of legs
- B: The presence of wings
- C: The diet of the animal
- D: The number of body parts

- (1) A and B only (2) A and D only
 (3) A, B and C only (4) A, C and D only

7. The table below shows the characteristics of three objects W, X and Y.

	W	X	Y
Bends easily	✓	✓	✓
Gets stretched easily	✓	✓	x
Absorbs water	x	✓	✓

Which one of the following sets of objects best fits the description in the table above?

	W	X	Y
(1)	Swim suit	Paper	Rubber band
(2)	Paper	Swim suit	Rubber band
(3)	Rubber band	Sponge	Paper
(4)	Paper	Rubber band	Swim suit

8. Mr Tan set up an experiment as shown below to find out the strength of different types of paper.

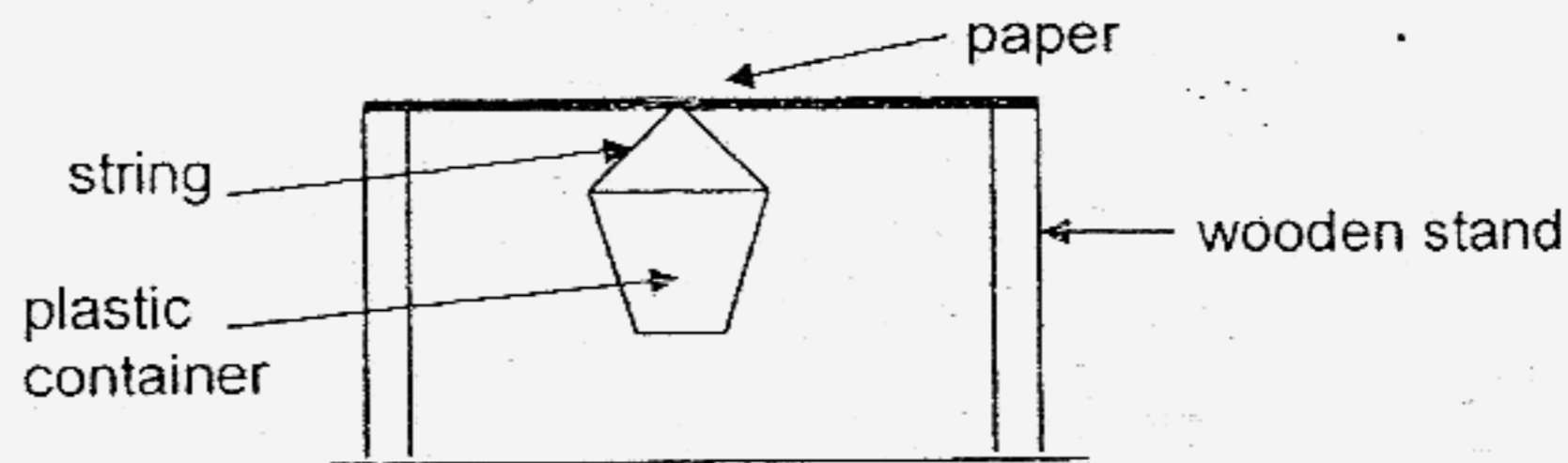

The number of coins the plastic container could hold before the paper tore was recorded in the table below.

Type of paper	Number of coins
Tissue paper	1
Art paper	10
Newspaper	4
Waxed paper	8

Based on the above results, which type of paper is the strongest?

- (1) Tissue paper (2) Art paper
 (3) Newspaper (4) Waxed paper

9. Look at the different animals as shown in the pictures below. Which animal reproduces differently from the others?

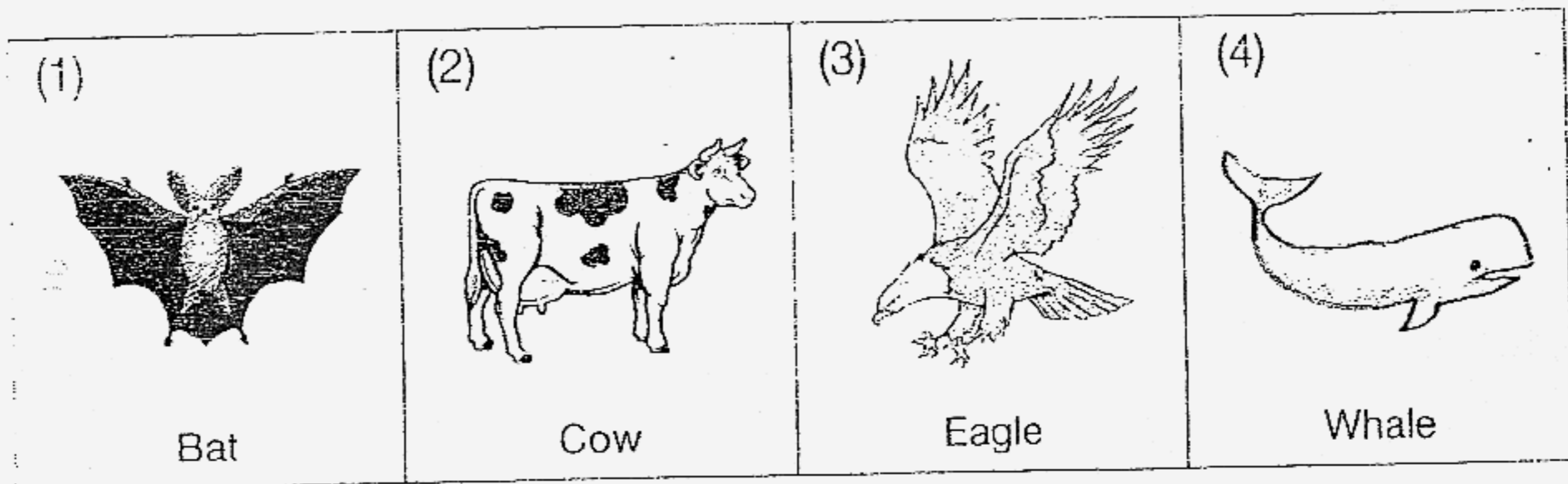

10. Cycles follow a pattern and repeat the pattern. Which of the following is not a cycle?

- (1) Movement of the Moon around the Earth
 (2) Changes from day to night
 (3) Changes in seasons
 (4) Changes in weather in a day

11. The diagram below shows the life cycle of a dragonfly.

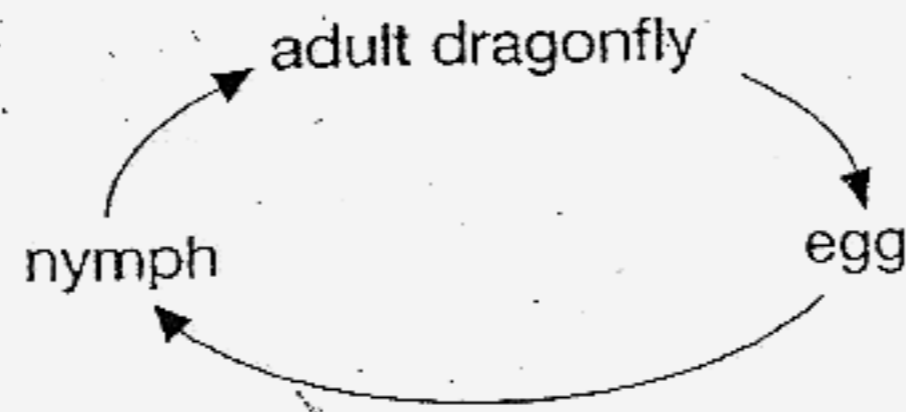

Which of the following animals goes through the same life cycle as the dragonfly?

- (1) Housefly
- (2) Mosquito
- (3) Rabbit
- (4) Cockroach

12. Study the 4 cycles shown below carefully. Which one of the following shows the life cycle of a plant correctly?

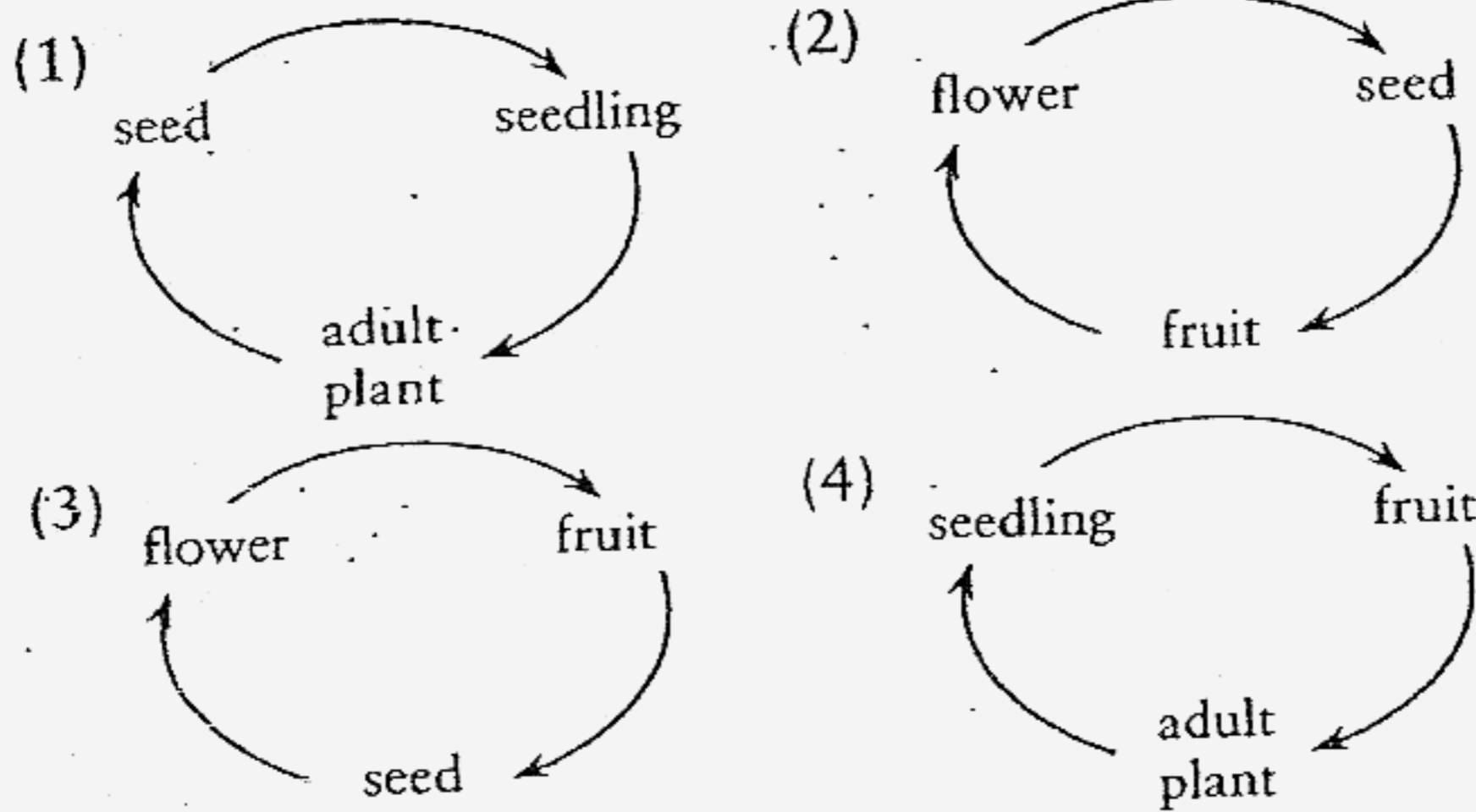

13. The stages of a seedlings' growth is shown below. This is not in the correct order of its growth.

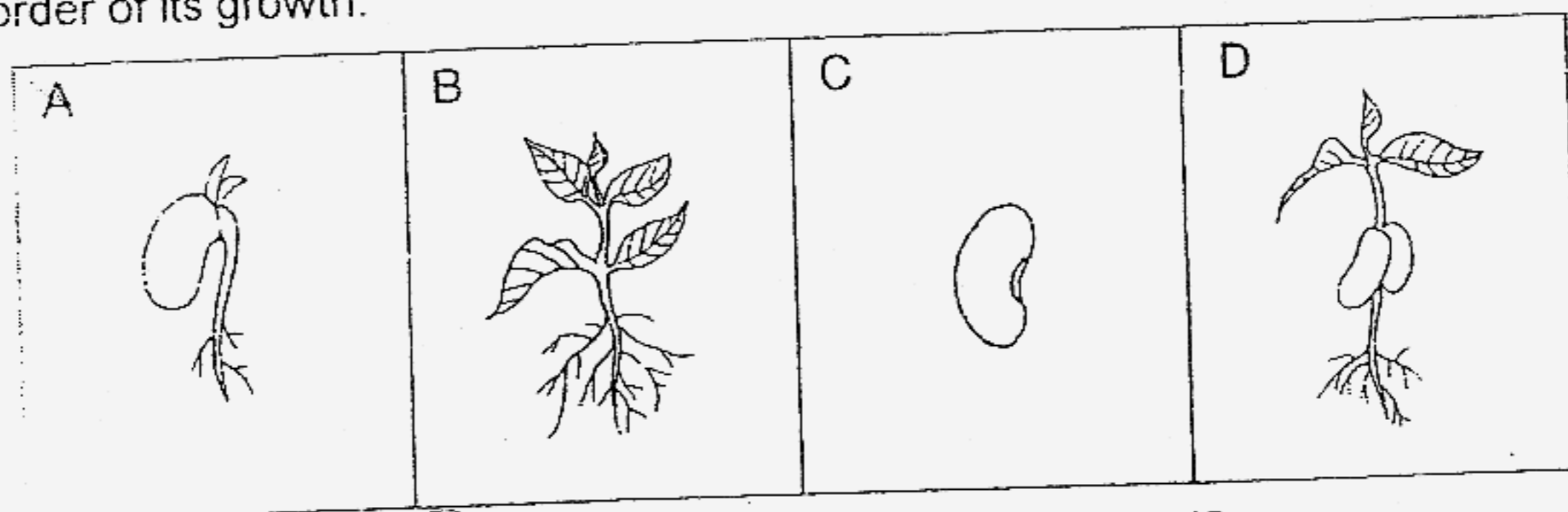

At which stage(s) is the seedling able to make its own food?

- (1) B only
- (2) C only
- (3) A and B only
- (4) B and D only

14. When a baby is born, the baby takes on some of the characteristics of his/her parents. Which one of the following is not passed on to the baby as a physical characteristic?

- | | |
|-------------------|------------------------|
| (1) Hair Colour | (2) Fingerprints |
| (3) Shape of face | (4) Colour of the eyes |

15. In an experiment, Peter was asked to pick out the bottle that contained some medicated oil.

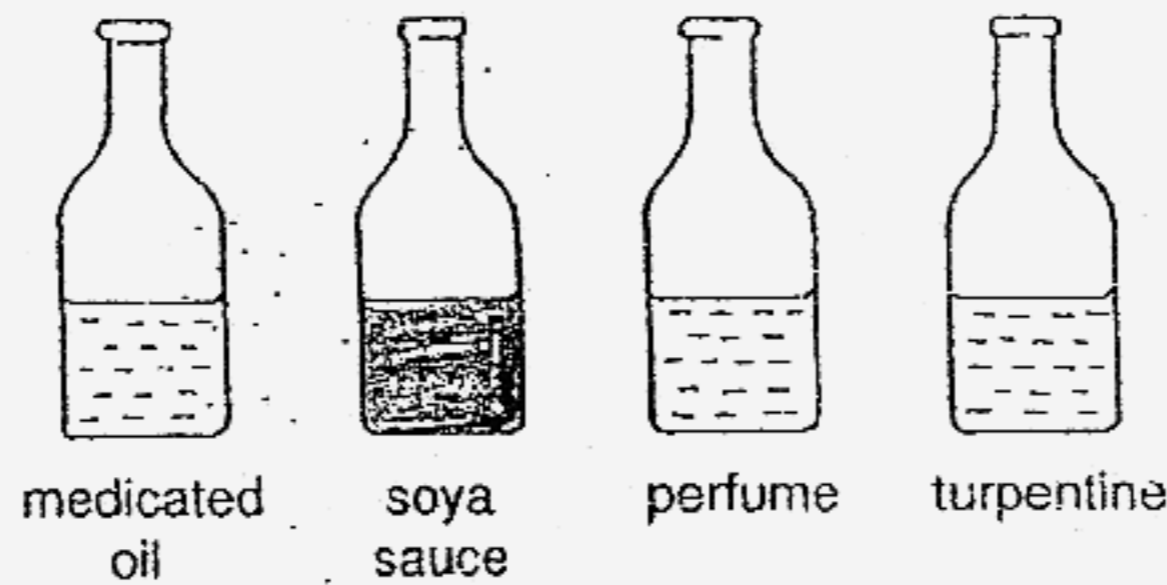

Which sense organs would help him pick out the right bottle without touching them?

- | | |
|------------------------------|-------------------|
| (1) Eyes and tongue | (2) Nose and ears |
| (3) Ears and nose | (4) Nose and eyes |

16. Ahmad made a few statements about his surrounding. Which of the following statements he made requires him to use his sense of hearing?

- A: I read that it may rain later this afternoon.
- B: The weather is very warm and humid today.
- C: The strong wind is howling.
- D: The leaves in the trees are rustling in the wind.

- | | |
|-------------|-------------|
| (1) A and B | (2) B and C |
| (3) C and D | (4) B and D |

17. Four jars, each containing five seeds, were shown below. Jars, A, B and C were placed near the window while Jar D was placed in the refrigerator.

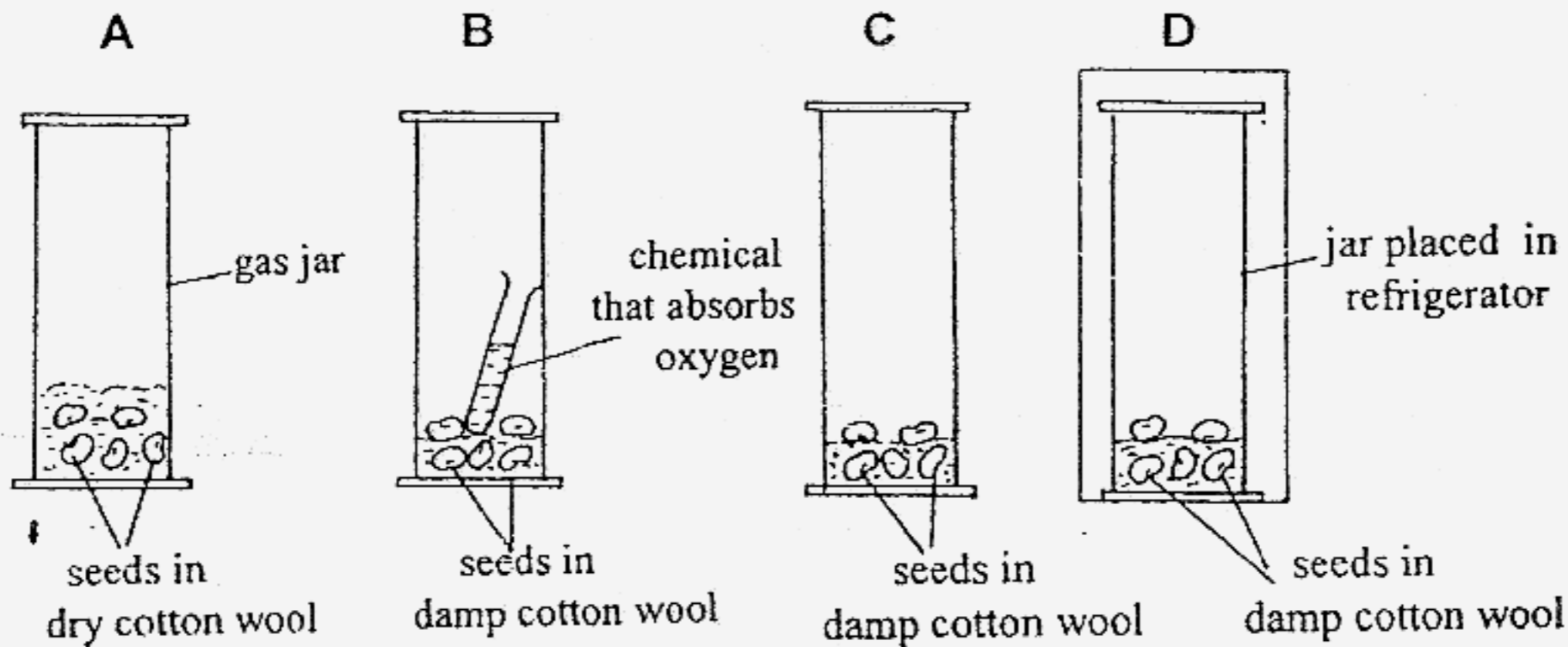

Which jars would you compare to confirm that warmth is needed for seeds to germinate?

- (1) A and C only
 (2) A and D only
 (3) B and C only
 (4) C and D only
18. Sally was blindfolded with a thick handkerchief and asked to differentiate the following items.

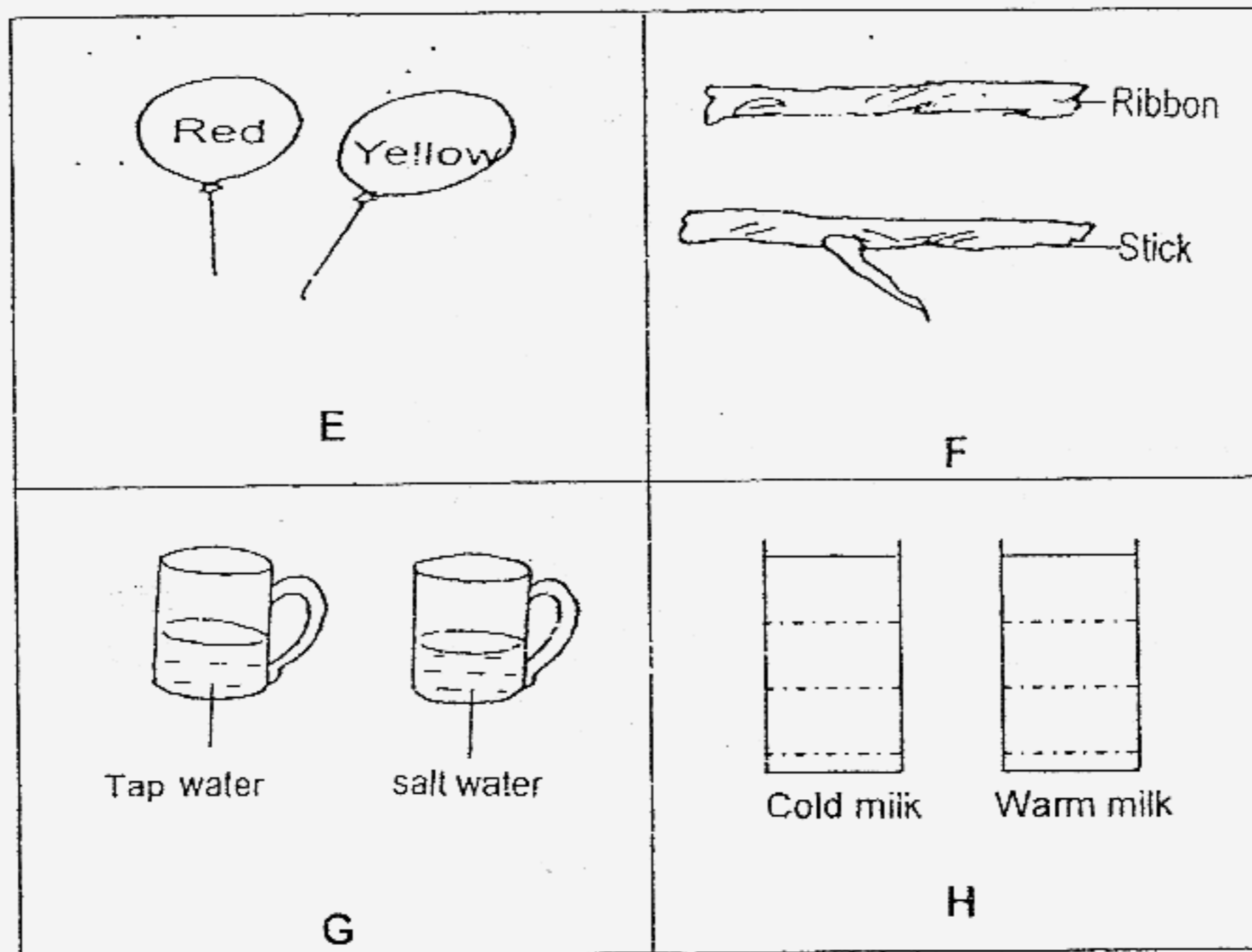

Which of the following would she be able to differentiate?

- (1) E and F only
 (2) G and H only
 (3) F, G and H only
 (4) E, F, G and H

19. John was observing some plants in his garden when he noticed that most plants had leaves that were spread out as shown in the diagram below.



Why were the leaves spread out in this manner?

- E: To trap rainwater when it rains.
 F: To attract insects.
 G: To trap insects for food.
 H: To get more sunlight.

- (1) E and H only (2) F and G only
 (3) E and F only (4) G and H only

20. Mrs Tan grinded some chicken pieces in a mixer until they turned into a liquid form.

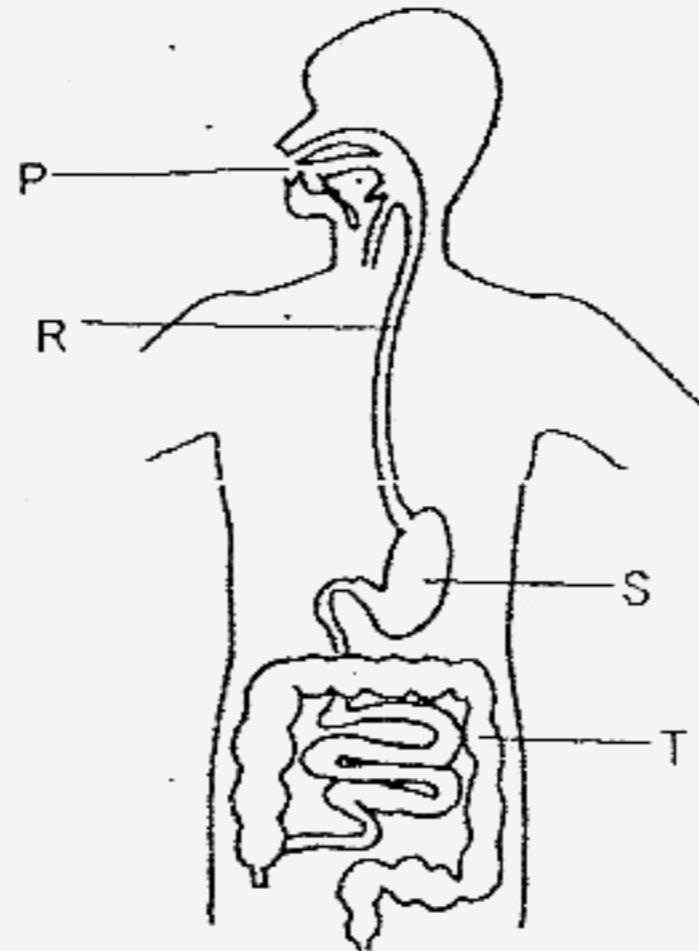

In which part (P, R, S, T) of the digestive system, would a similar change take place if Mrs Tan ate some chicken pieces only?

- (1) P (2) R
 (3) S (4) T

21. Which one of the following correctly shows where digestion begins and where it ends?

	Digestion begins in the..	Digestion ends in the..
(1)	Mouth	Stomach
(2)	Stomach	Large intestine
(3)	Mouth	Small intestine
(4)	Stomach	Small intestine

22. The diagram below shows a human arm.

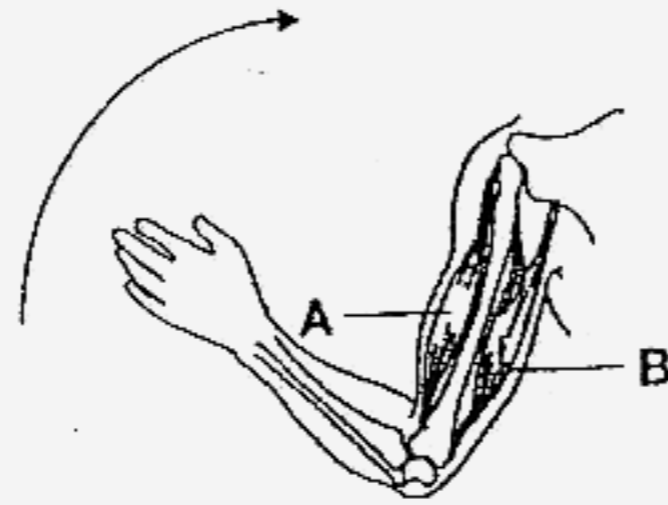

Which one of the following describes the action of muscles A and B when the arm is bent?

	Muscle A	Muscle B
(1)	Contracts	Contracts
(2)	Contracts	Relaxes
(3)	Relaxes	Contracts
(4)	Relaxes	Relaxes

23. Which of the following actions does not make use of the skeletal system to perform the action?

<p>A)</p> <p>Climbing up the stairs</p>	<p>B)</p> <p>Writing</p>
<p>C)</p> <p>Playing golf</p>	<p>D)</p> <p>Smelling some flowers</p>

- (1) A
(3) C

- (2) B
(4) D

24. The graph below shows the length of the skeleton of a fish at different ages.

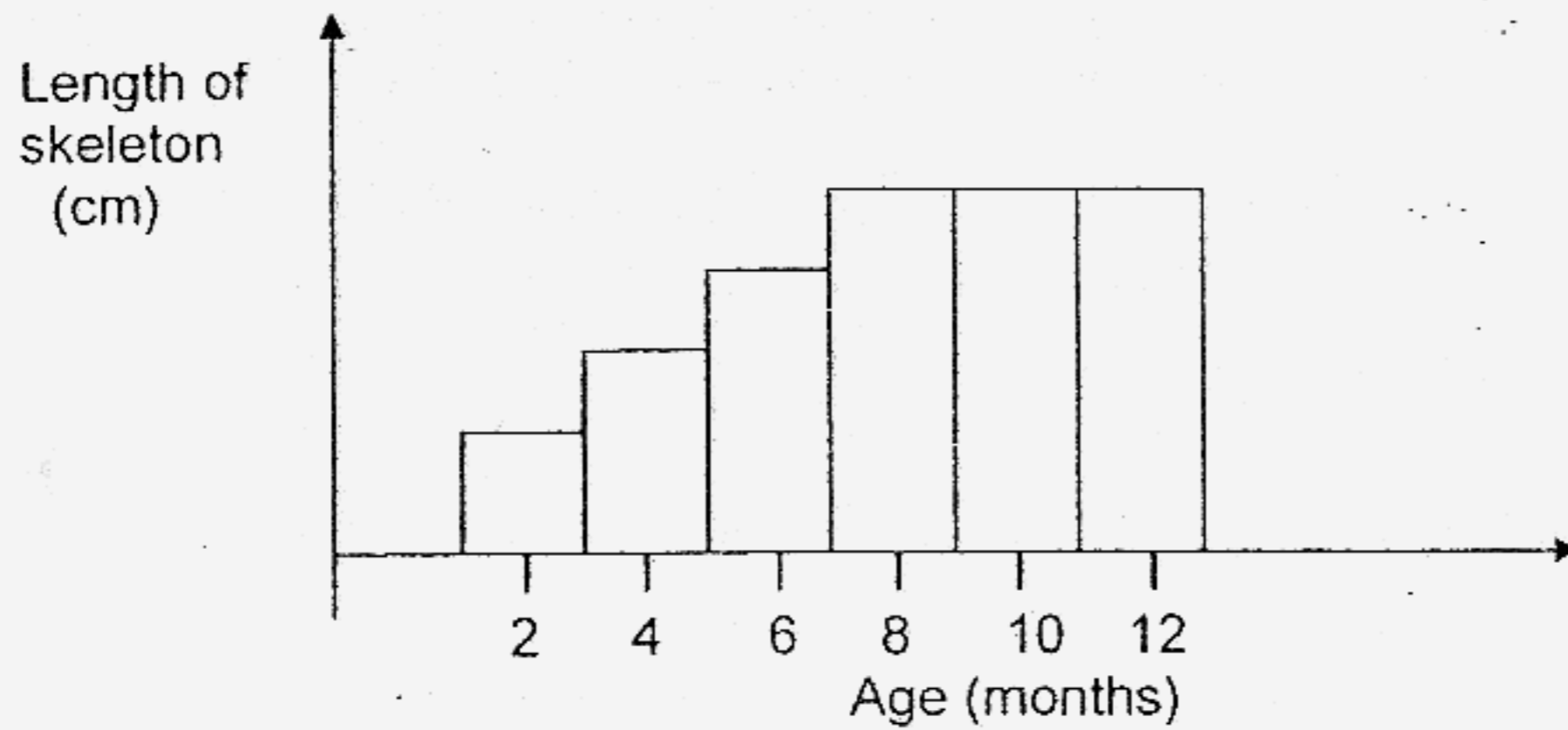

What pattern do you observe about the length of the skeleton of the fish and its age?

- (1) The length of the skeleton increases as the fish grows older.
- (2) The length of the skeleton remains the same as the fish grows older.
- (3) The length of the skeleton increases and then decreases as the fish grows older.
- (4) The length of the skeleton increases at first and then remains the same as the fish grows older.

25. Look at the diagram of the human skeletal system below.

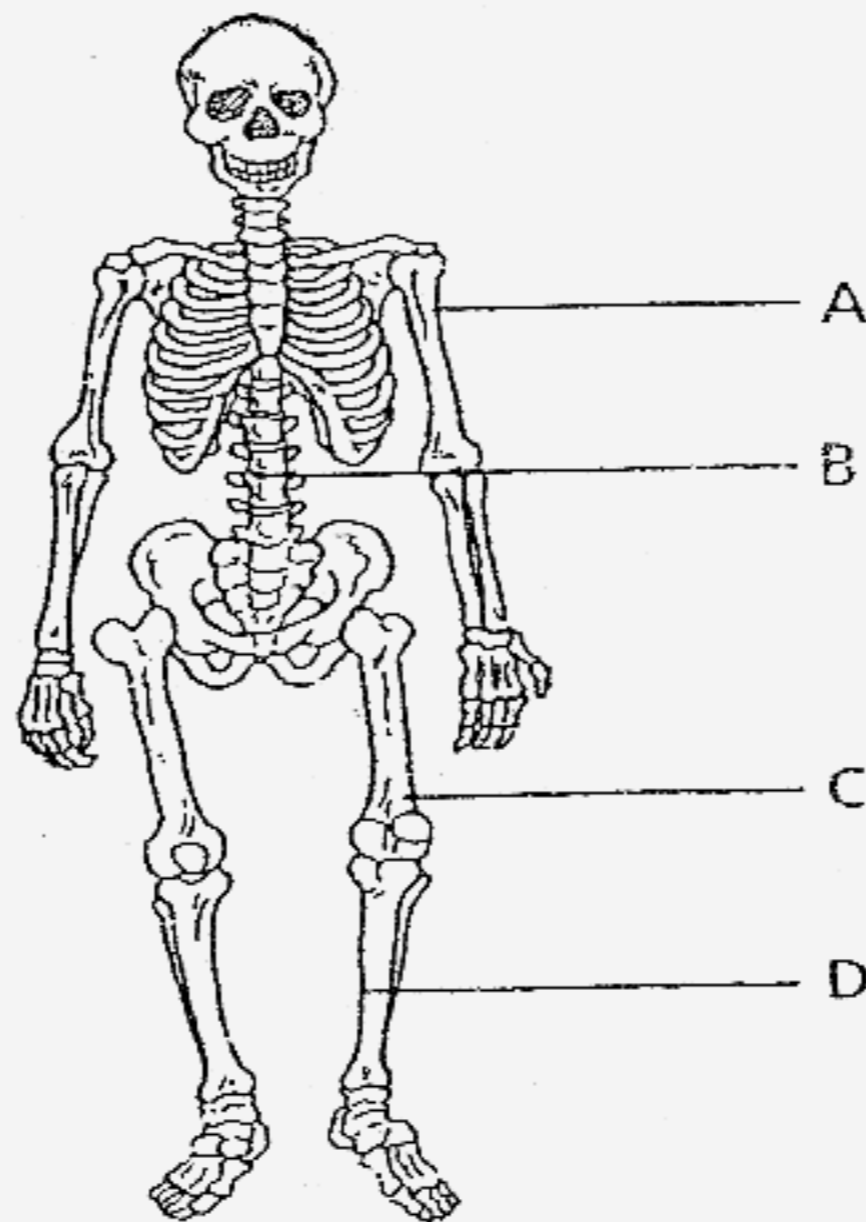

Which one of the following sets represents the parts correctly?

	A	B	C	D
(1)	Arm bone	Backbone	Leg bone	Toe bone
(2)	Ribcage	Arm bone	Hip bone	Thigh bone
(3)	Arm bone	Backbone	Thigh bone	Shin bone
(4)	Thigh bone	Ribcage	Shin bone	Shoulder bone

26. The following materials have been grouped according to their magnetic properties by Steven. Study the table below carefully.

MAGNETIC	NON-MAGNETIC
Copper	Rubber
Iron	Steel
Nickel	Gold

Steven's teacher pointed out that 2 of them were wrongly grouped. Which materials are wrongly grouped?

- (1) Nickel and Iron (2) Steel and Copper
 (3) Gold and Nickel (4) Copper and Rubber
27. Sam brought a magnet close to a metal bar. The metal bar was attracted to the magnet. Sam then made the following statements:

Statement J: The metal bar is made of magnetic material.
 Statement K: The metal bar is made from copper or gold.
 Statement L: The metal bar could be a magnet.

Which of the above statement(s) is/are correct?

- (1) J only (2) L only
 (3) J and L only (4) J and K only
28. Sandra set up an experiment using an object as shown in the diagram below.

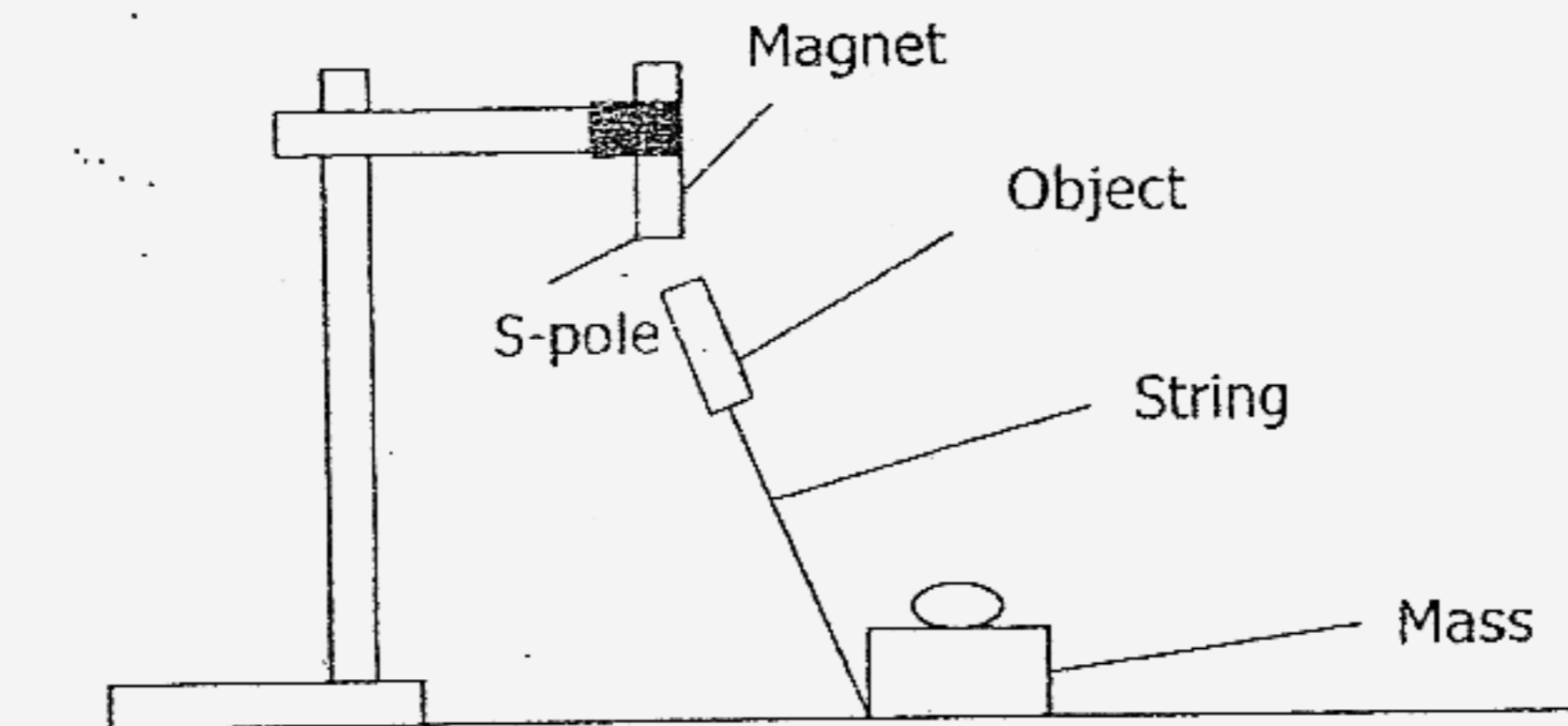

Which one of the following cannot be the material the object is made of?

- (1) Silver (2) Steel
 (3) Cobalt (4) Iron

29. A matchbox containing an unknown object was placed on a thin sheet of cardboard as shown below.

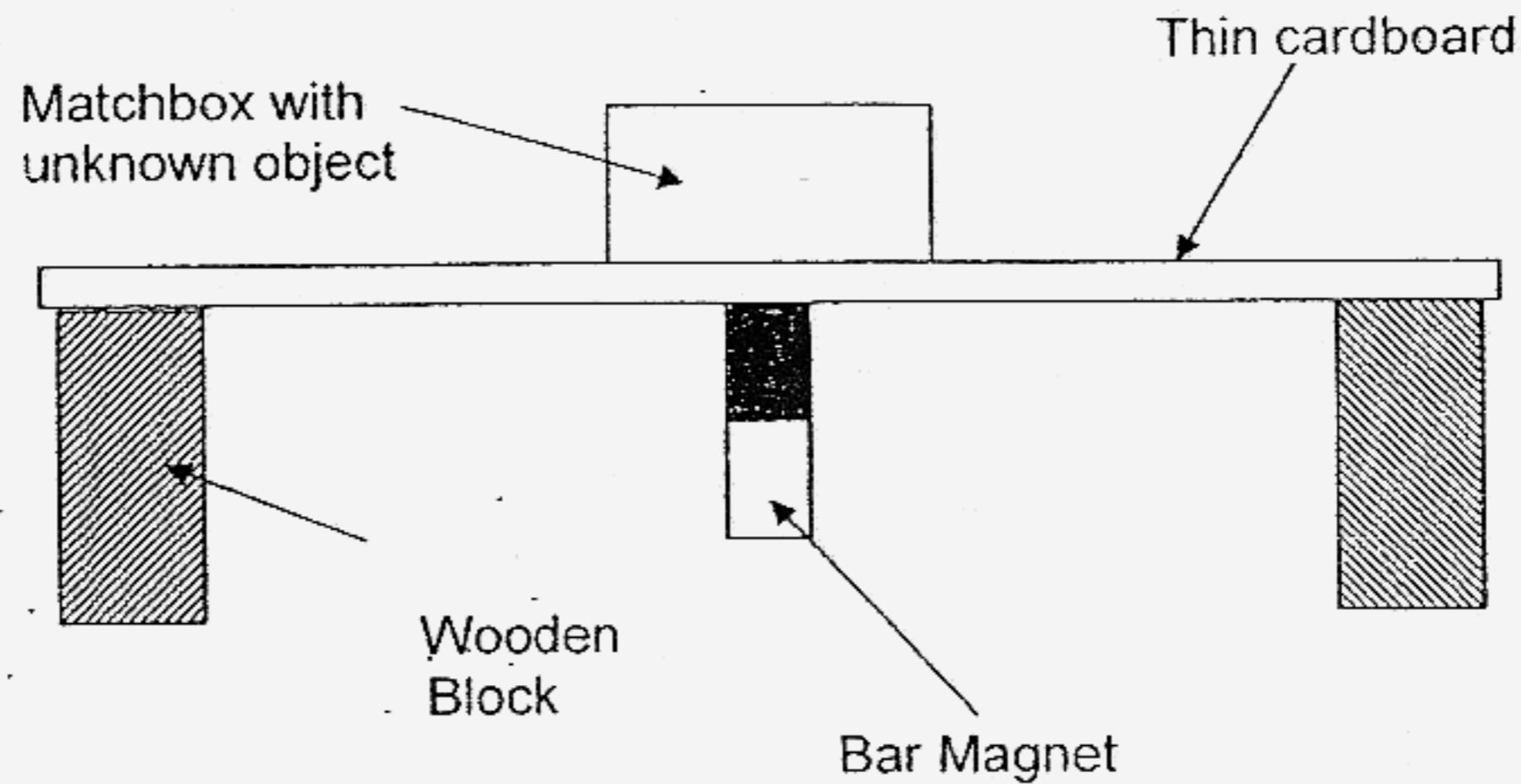

- When the bar magnet moved, the matchbox moved along with it. Which one of the following was most likely to be the unknown object?
- (1) Copper coin (2) Gold ring
 (3) Aluminium rod (4) Steel ball bearing
30. Mrs Lim carried out an experiment with a bar magnet and two objects, M and N as shown below.

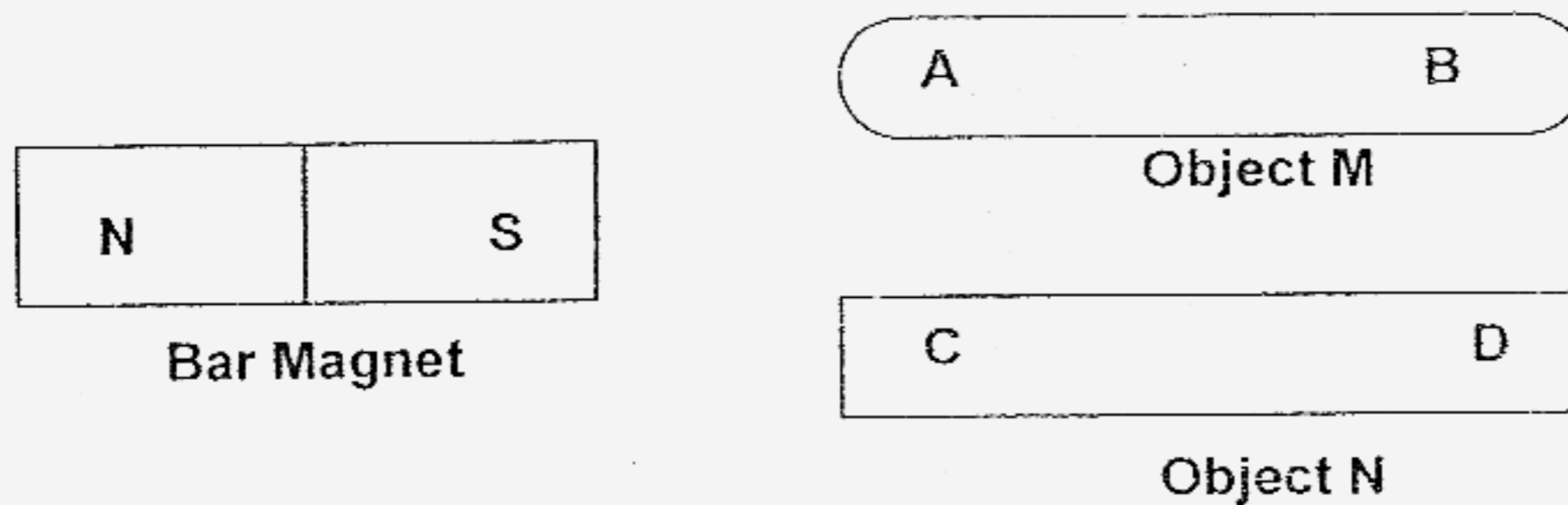

She observed what happened when the South Pole of the magnet was brought close to side A of object M and then to side B. She repeated the experiment with object N and recorded her observations. Which one of the following would tell her that object M is a magnet while object N is not?

	A	B	C	D
(1)	Attract	Repel	Attract	Repel
(2)	Attract	Attract	Repel	Attract
(3)	Repel	Attract	Attract	Attract
(4)	Repel	Repel	Attract	Attract

End of Booklet A



Rosyth School
Second Semestral Assessment for 2007
SCIENCE
Primary 3

Name: _____

Total
Marks:

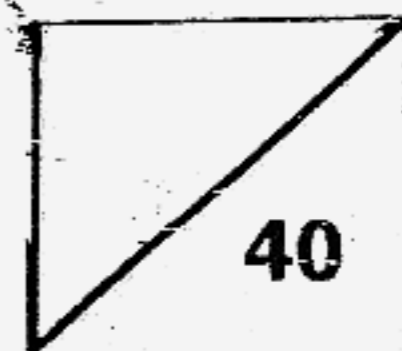

Class: Pr _____

Register No. _____

Duration: 1 h 30min

Date: 1 November 2007

Parent's Signature: _____

Booklet B

Instructions to Pupils:

1. For questions 31 to 46, give your answers in the spaces given in this Booklet B.

* This booklet consists of 14 pages. (Pg. 13 to 26)

This paper is not to be reproduced in part or whole without the permission of the Principal.

Part II (40 MARKS)

For questions 31 to 46, write your answers in this booklet.

31. Study the flowchart below. The letters P, Q, R, S, T and U represent six different animals.

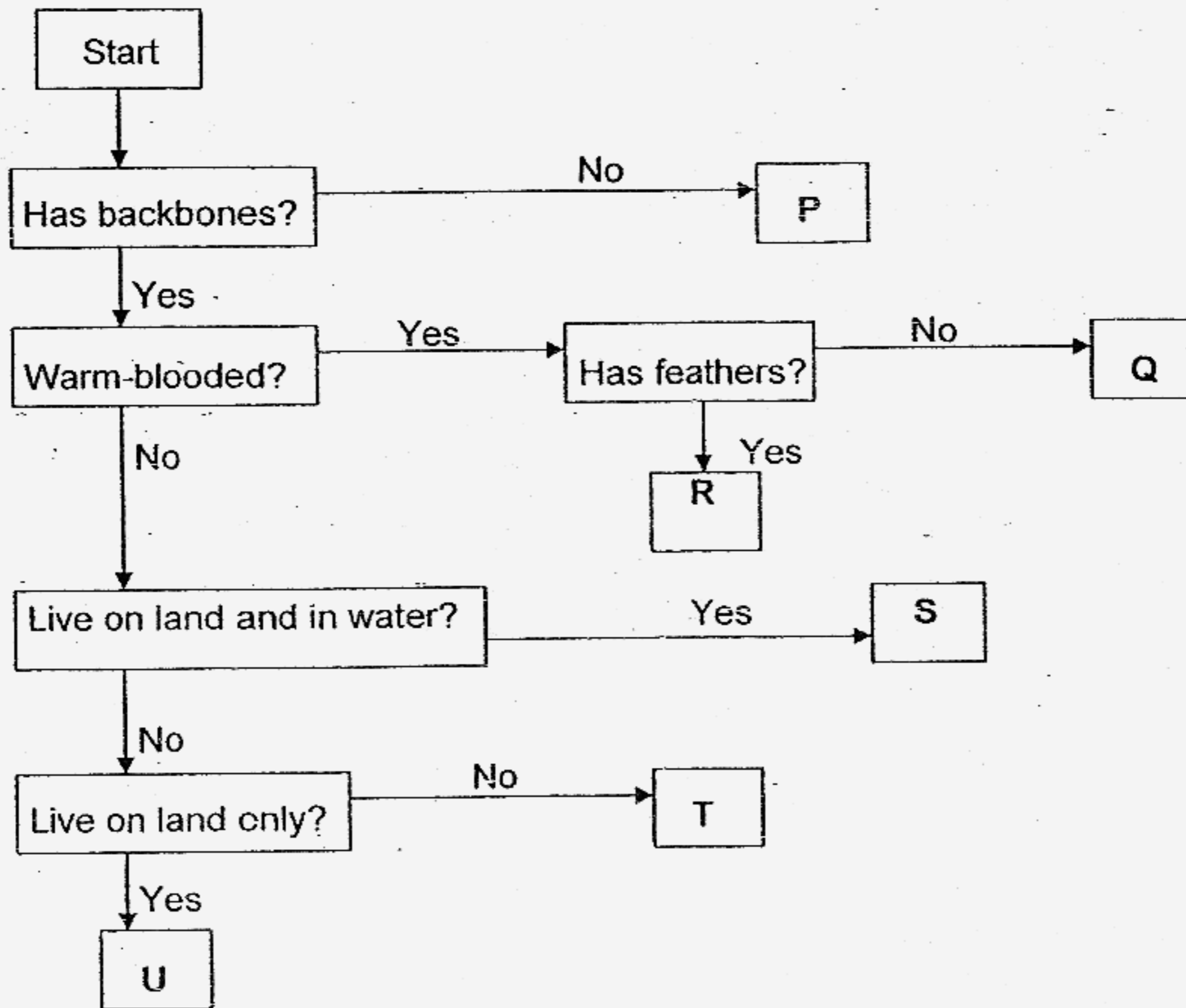

Identify the letter that best represents each of the following animals. (3m)

- (a) Owl : _____
- (b) Frog : _____
- (c) Grasshopper : _____
- (d) Lizard : _____
- (e) Guppy : _____
- (f) Whale : _____

32. Study the flowchart below carefully.

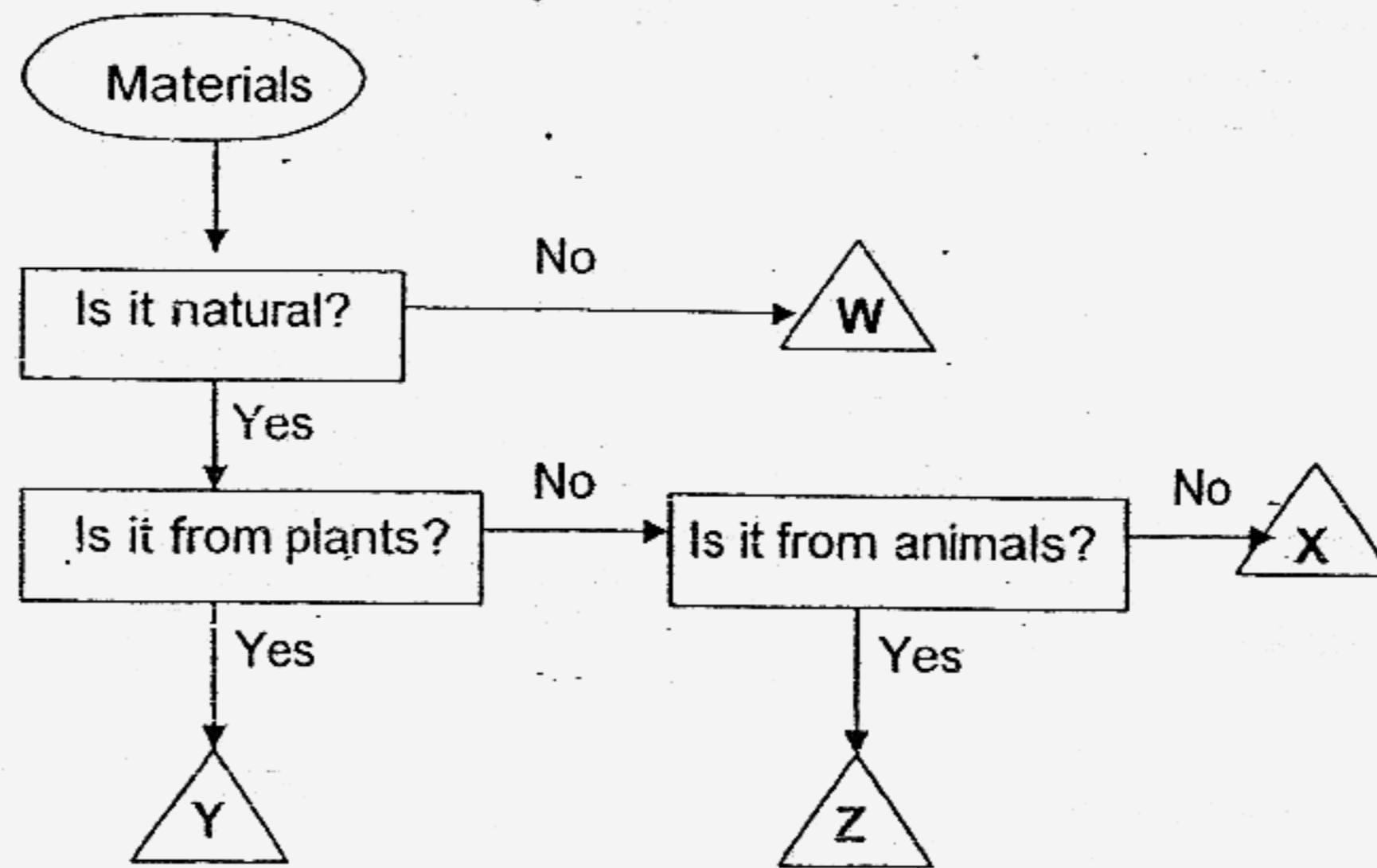

(a) State a similarity between Y and Z. (1m)

(b) In which group (W, X, Y or Z) would you place iron? Explain why. (1m)

33. John wanted to find out which material makes a good hand towel that dries wet hands well. Four different materials of the same size and shape were used and the experiment was set up as shown below.

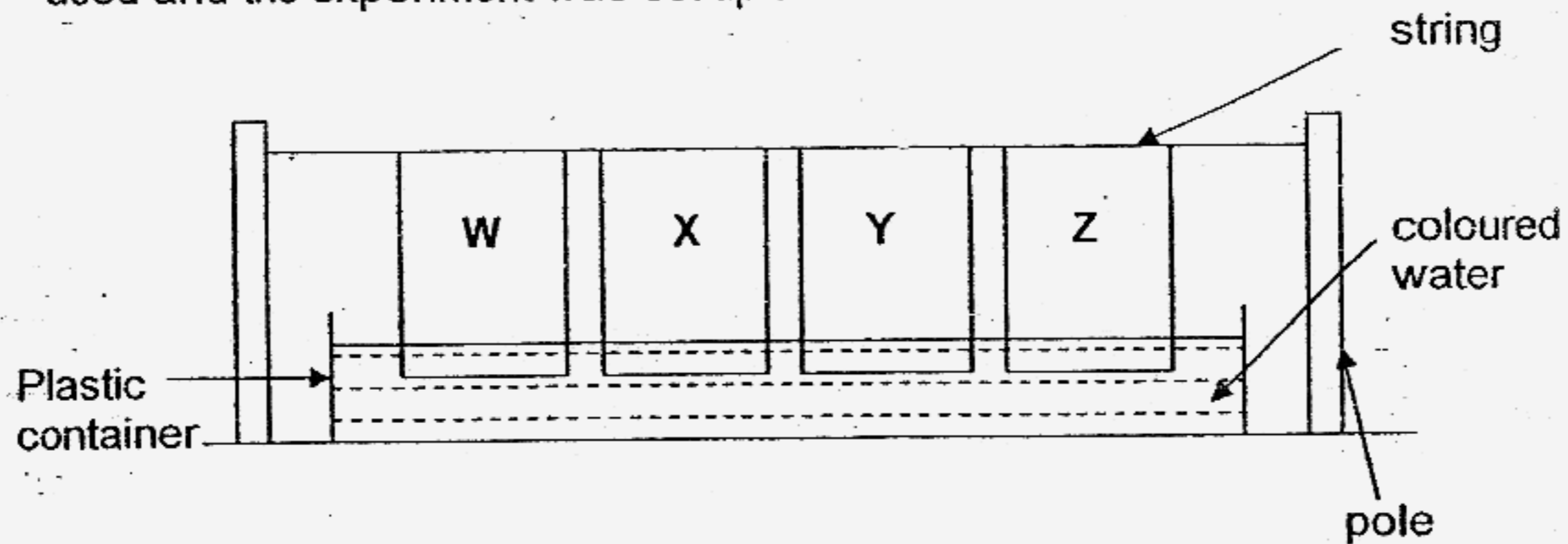

He measured the height in which the water rose in 3 minutes. The results are shown in the table below.

Material	Height in which the water rose (cm)
W	15
X	5
Y	1
Z	3

- (a) Which material (W, X, Y or Z) would be the best material to make a hand towel? (1m)

- (b) Explain why you have chosen the material you have identified in (a). (1m)

34. Su Ning wanted to grow a butterfly on her own to study its growth. She got a butterfly egg and placed the egg in a box as shown below.

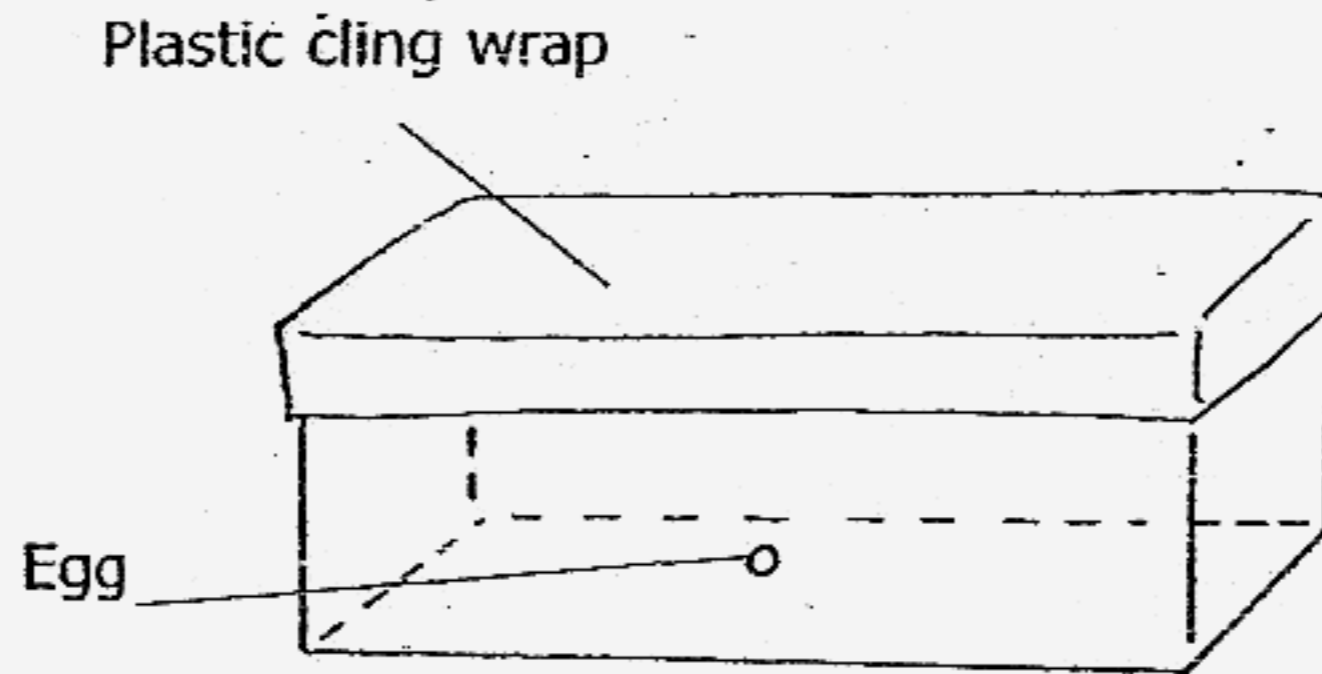

- (a) What two things should she do to the set-up so that she can ensure the butterfly will survive in the box she has made? (2m)

- (b) If Su Ning did not do the two things mentioned in (a), at what stage would the butterfly reach before it is unable to survive any longer? Name the stage. (1m)

35. Jeya placed an equal number of water plants in containers D and E. In container E, he poured in some oil. He then placed both containers at his balcony.

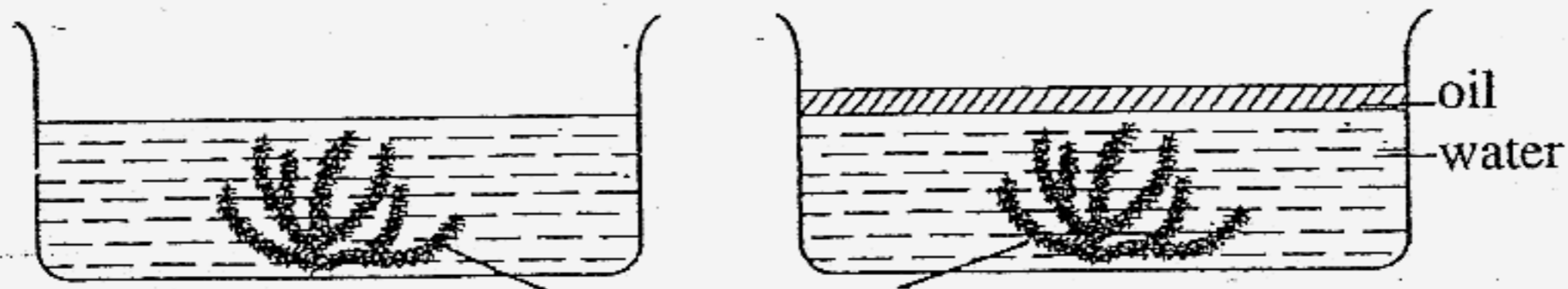

Water Plants

Container D

Container E

- (a) What would happen to the water plants in both containers D and E after a week? (1m)

- (b) Explain your answer in (a). (1m)

36. The table below shows the plant parts that are being removed from three balsam plants K, L and M.

Plant	Part that is removed
K	Fruits
L	Flowers
M	Leaves

- (a) Which plant will die first? (1m)

- (b) Explain your answer in (a). (1m)

37. Jimmy conducted an experiment with two potted plants. He placed one pot of plant each in a sealed black box with an opening on one side of the box. He watered the plants daily. The diagram shows what happened to the plants after a week.

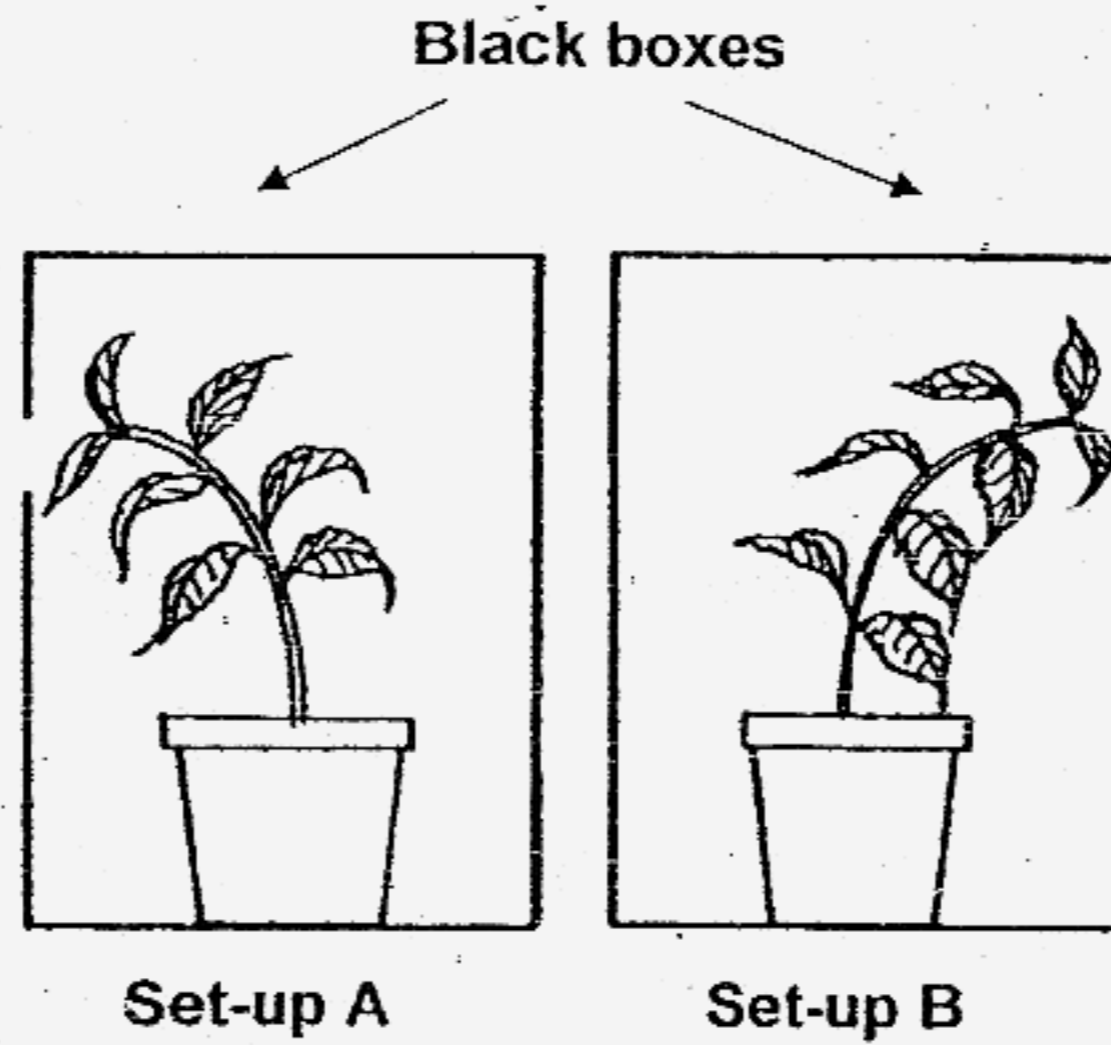

- (a) Jimmy concluded that the plants grew this way as there was no room for it to grow upwards. Is his conclusion correct? Explain your answer. (2m)

- (b) Explain why was it important for Jimmy to use black boxes in his experiment. (1m)

38. Raymond carried out an experiment with the set-up as shown below.

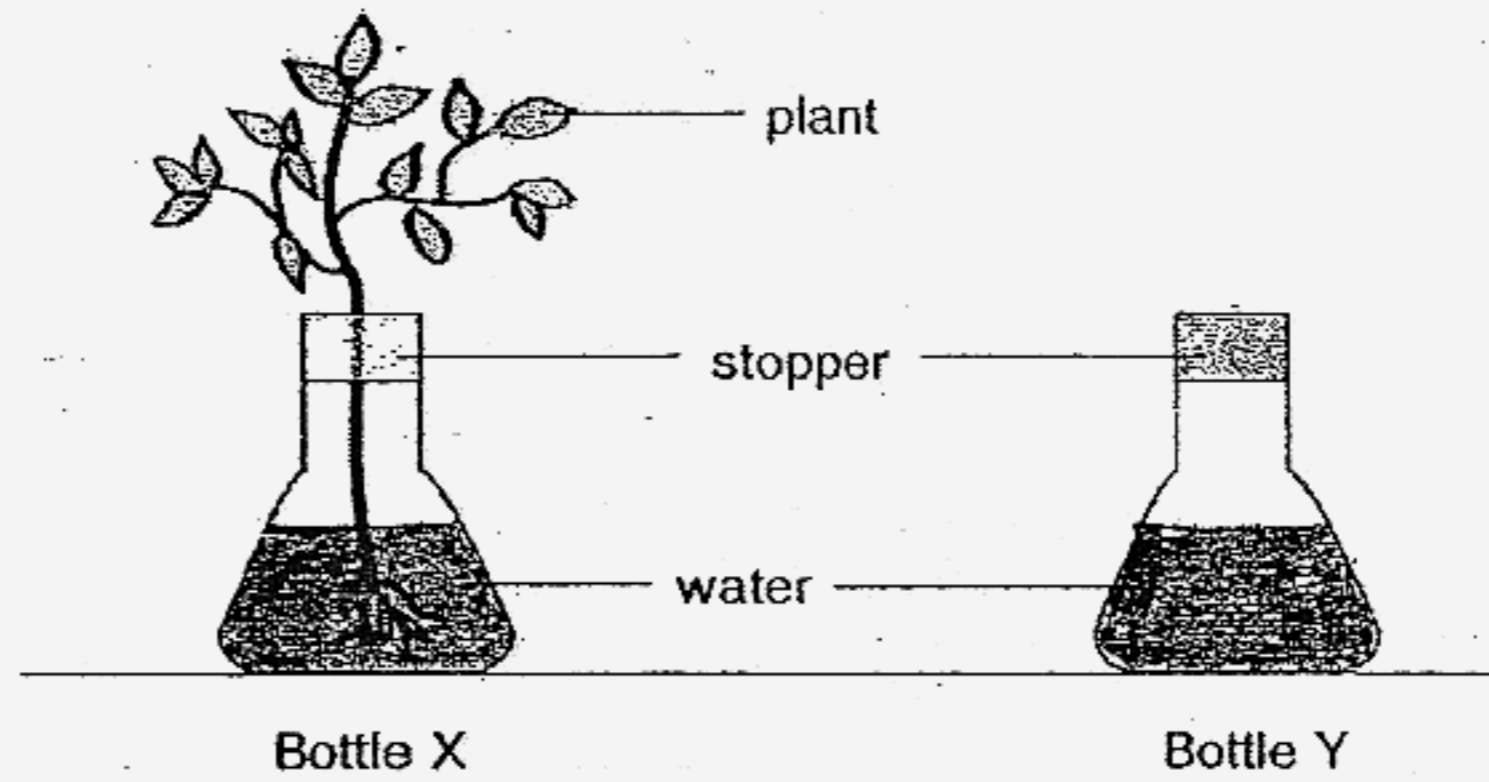

He then left the set-up for two days and recorded some information from his experiment. He put them in a table as shown below.

DATE	BOTTLE X	BOTTLE Y
16. Nov 06	200ml	200ml
18 Nov 06	180 ml	200ml

(a) What was the reason for the change in the volume of water in Bottle X? (1m)

(b) (i) Raymond then decided to reduce the change in the volume of the water in the bottle X. What two changes could he do to the plant used without replacing it completely? (2m)

(ii) Provide a reason as to why one of the changes above would cause a decrease in the loss of water in Bottle X? (1m)

39. Tammy made the following descriptions about some objects. Write down the sense organs which she used to describe them. (3m)

	Description	Sense organs used
(a)	The sweet-smelling rose is pink.	(i) _____ (ii) _____
(b)	The apple pie is warm and sweet.	(i) _____ (ii) _____
(c)	The stone is black and rough.	(i) _____ (ii) _____

40. Draw straight line to link two dots to match the following body systems to their functions. (2m)

(a)	Skeletal system	•	•	Takes oxygen into the body and removes carbon dioxide from the body
(b)	Circulatory system	•	•	Gives body its shape
(c)	Muscular system	•	•	Carries oxygen, food and water round the body
(d)	Respiratory system	•	•	Works with another body system to bring about movement

41. The pictures below show a skull and a ribcage. Using the graphic organiser below, state a similarity and a difference between them. (2m)

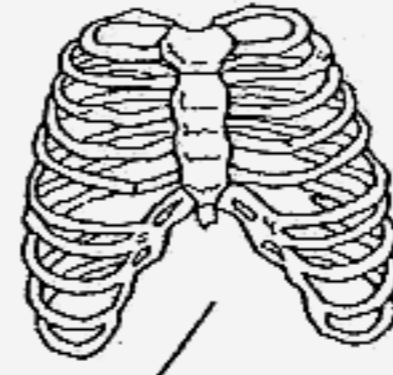

Similarity

i)

Body system : _____

Differences

ii)

Body part(s)
it protects

iii)

42. The picture below shows a human digestive system.

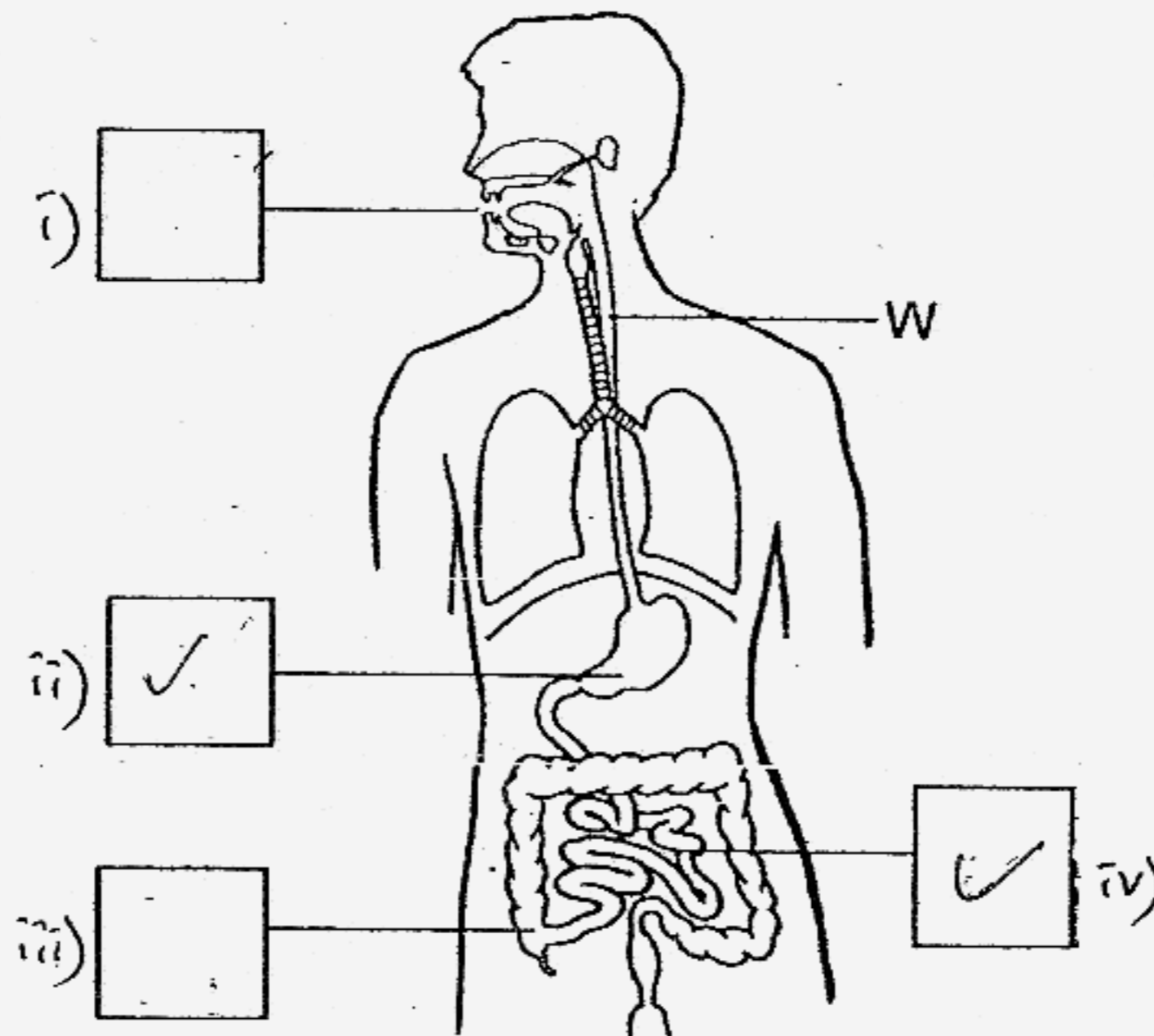

- (a) On the box(es) above, put a tick (✓) to indicate where digestion of food takes place. (1m)
- (b) On the box(es) above, put a (✗) to indicate where water is removed. (1m)
- (c) Identify the part that is labelled **W**. (1m)
-
- (d) State the function of the part labelled **W**. (1m)
-

43. Look at the diagram below carefully.

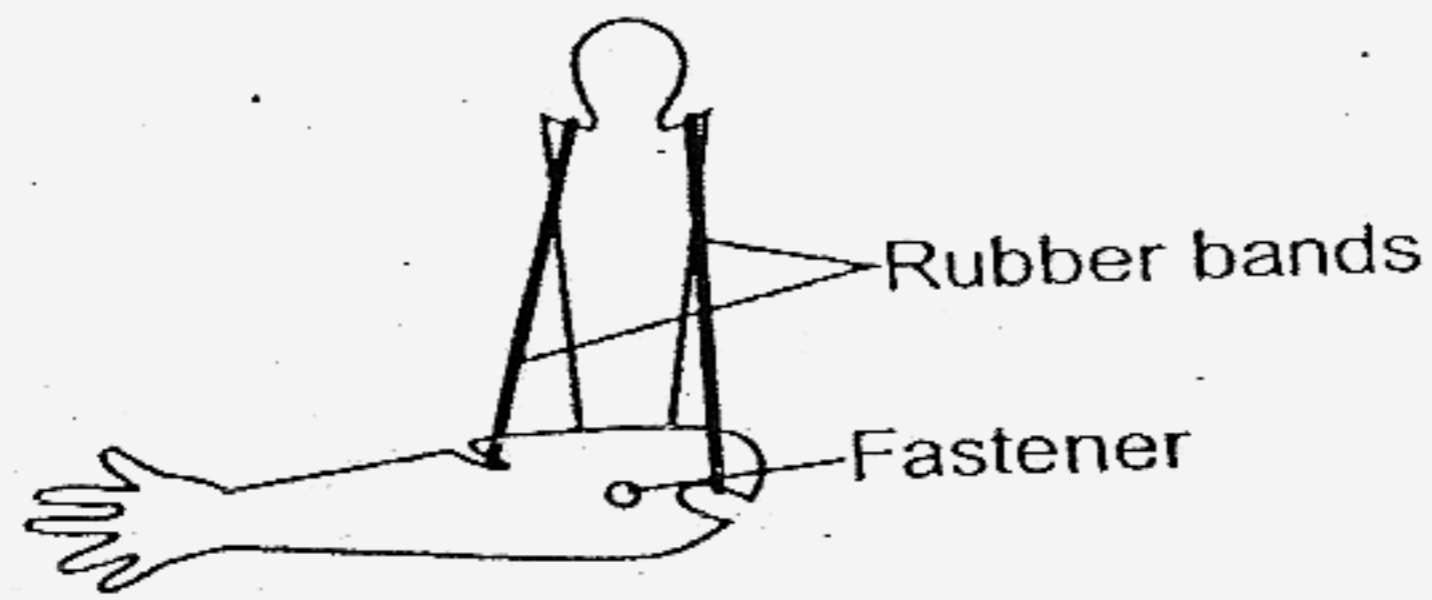

(a) Which part of our body do the rubber bands represent? (1m)

(b) Why is the part represented by the 'fastener' important to us? (1m)

44. Angela placed some pins near a U-shaped magnet. She then recorded the number of pins attached to different parts of the magnet in a table as shown below.

Position	Number of pins attached
K	2
L	6
M	14

- (a) On the diagram of a U-shaped magnet shown below, label the positions **K** and **M**, on only 2 of the boxes, based on the data given above. (1m)

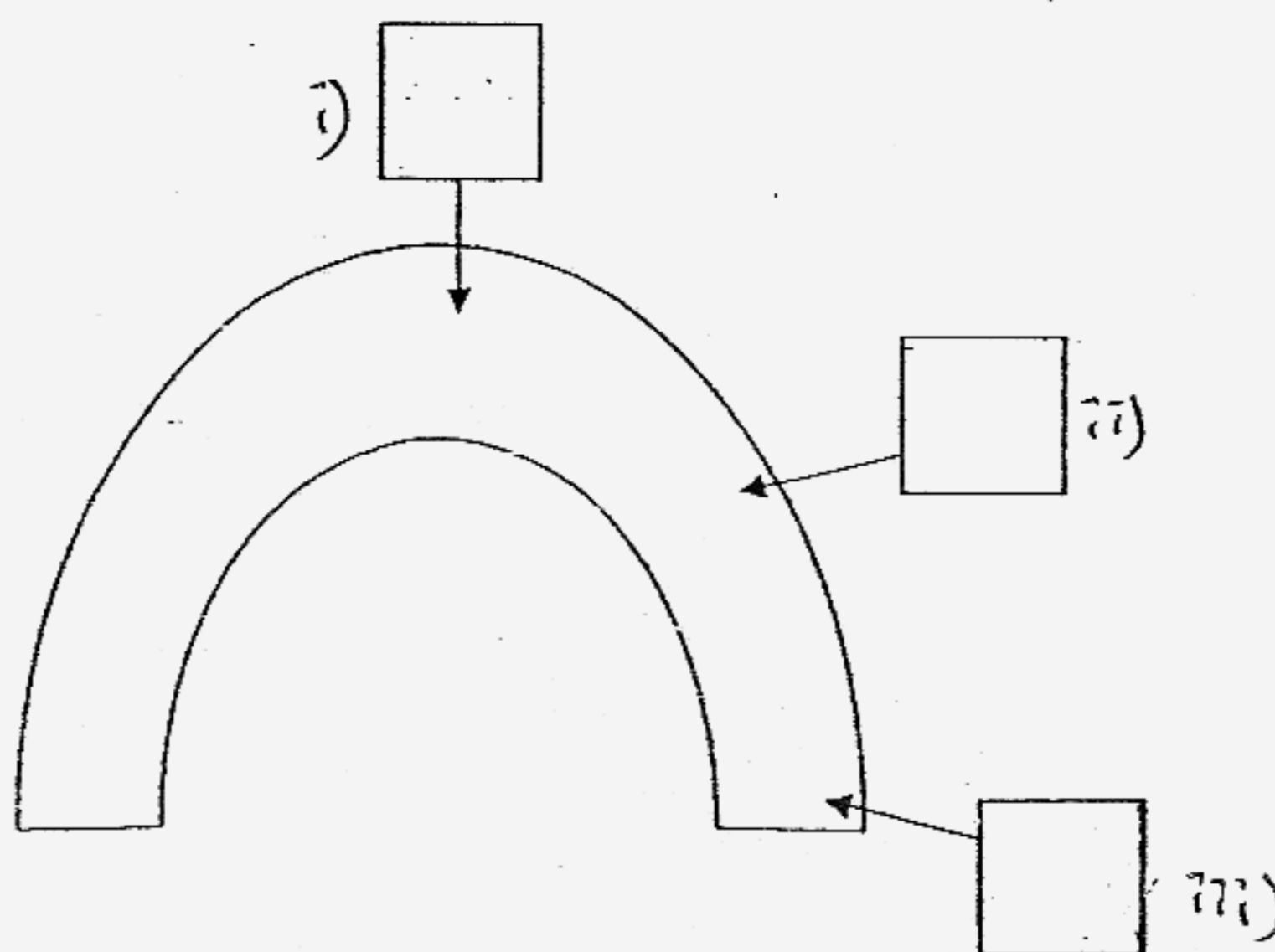

- (b) What can you conclude about the pull of the magnet from this experiment? (1m)

45. Helen mixed up some sugar and iron staples together into a mixture as shown in the diagram below.



Mixture of iron staples and sugar

- (a) How can Helen separate the iron staples from the sugar without using water? (1m)

- (b) Using the same idea in (a), explain how the crane below helps to sort out rubbish. (1m)

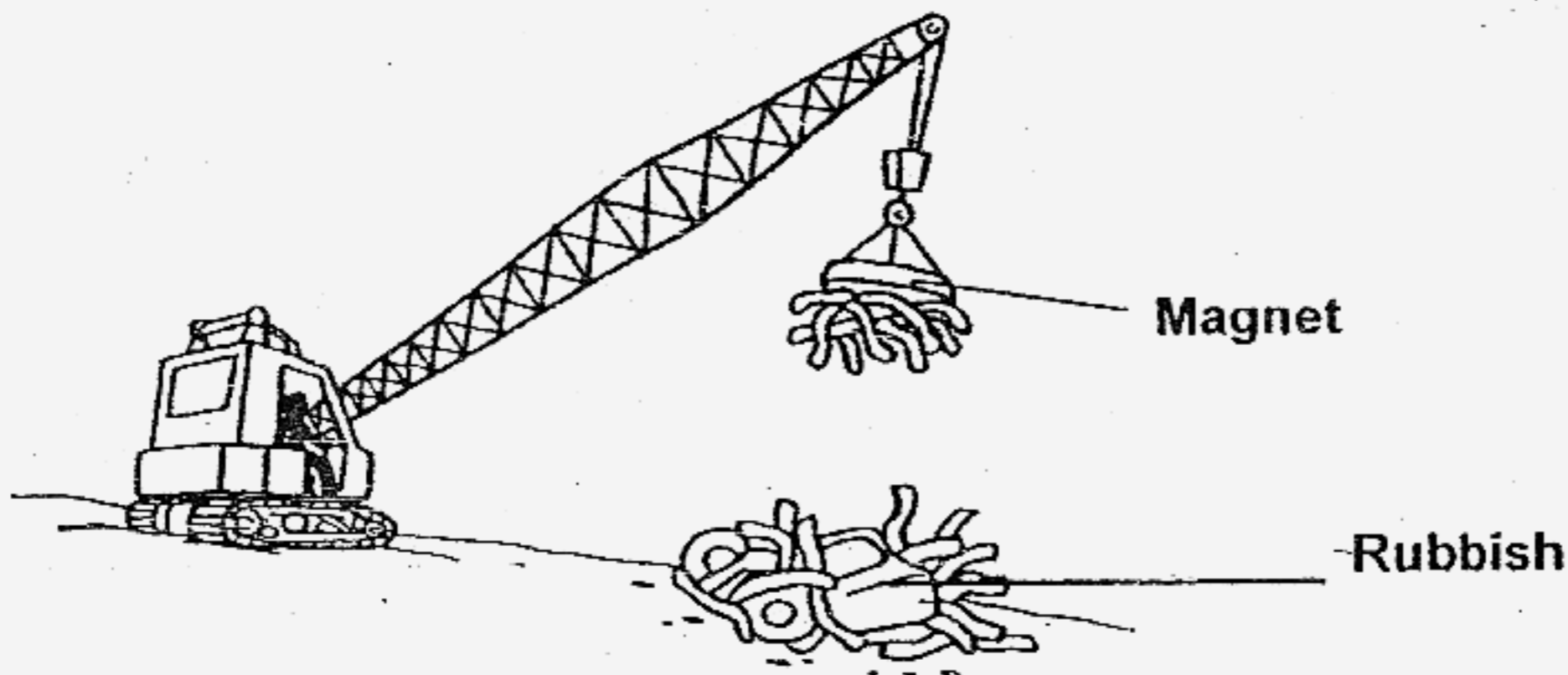

46. Magnets were attached to two toy cars as shown below.

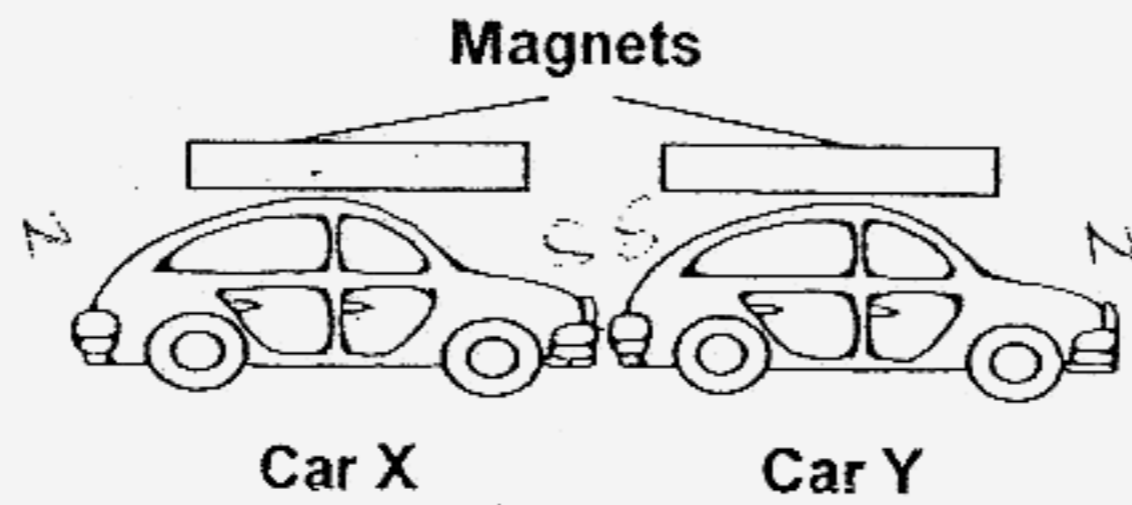

- (a) When Car X was brought close to Car Y, Car Y moved away from Car X. Explain why this happened. (1m)

- (b) What would happen if we turned the two cars such that Car X and Car Y were facing each other as shown below? (1m)

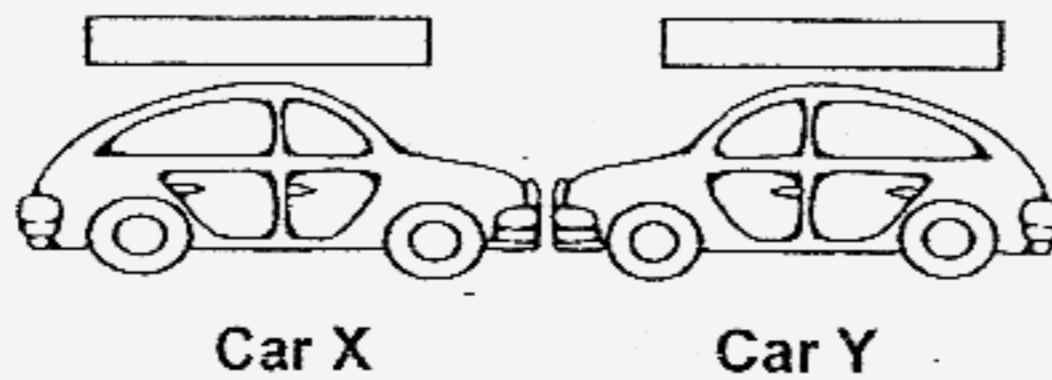

End of Paper

Rosyth Primary School

Primary 3 Science SA2 Exams (2007)

Answer Keys

SECTION A : (60 MARKS)

Qn no.	Ans
1	1
2	3
3	4
4	3
5	2
6	2
7	3
8	2
9	3
10	4

Qn no.	Ans
11	4
12	1
13	4
14	2
15	4
16	3
17	4
18	3
19	1
20	3

Qn no.	Ans
21	3
22	2
23	4
24	4
25	3
26	2
27	3
28	1
29	4
30	3

SECTION B (40 MARKS)

- 31a. R
31b. S
31c. P
31d. U
31e. T
31f. Q

- 32a. Y and Z are natural materials
32b. I would place iron in X. It is natural but does not come from plants or animals.

- 33a. Material W
33b. It absorbs the most water in the experiment.

- 34a. The first thing: Put some green leaves in the box for the caterpillar to eat.
The second thing: Make air holes in the cling wrap to let some air in for the caterpillar and butterfly to breathe.

- 34b. The larva stage = Caterpillar

- 35a. The water plant in container D will survive while the water plant in container E will die.

- 35b. The water plant in container D can get air in the water while the water plant in container E cannot get air in the water as the oil is blocking it.

- 36a. Plant M will die first.

- 36b. Without leaves, plant M will not be able to make food for photosynthesis.

- 37a. His conclusion is wrong. The plant grow towards the hole to get sunlight to make food.
- 37b. It is important to use black boxes in his experiment because the light could not enter the boxes and the experiment would be accurate.
- 38a. Roots absorbed the water.
- 38b. (i) He could cut off some roots.
(ii) He could also pluck off some leaves.
- 39a. (i) Nose
(ii) Eyes
- 39b. (i) Skin
(ii) Tongue
- 39c. (i) Eyes
(ii) Skin

40

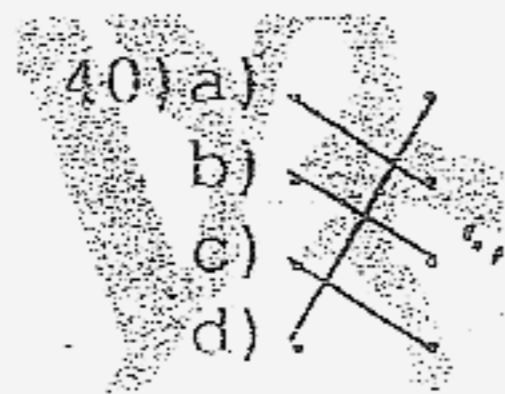

41. A: Skeletal System
B: Brain
C: Heart and Lungs
- 42a&b. (i) ✓ (iii) ✗
- 42c. Gullet
- 42d. The chewed food travels down the gullet to the stomach.
- 43a. They represent our muscles.
- 43b. It enables us to move our arm.
- 44a. (i) K (ii) M
- 44b. Magnets are strongest at the poles.
- 45a. She can use the magnet to attract the iron staples.
- 45b. It separates magnetic material from non-magnetic materials.
- 46a. They like poles were facing each other and hence, they repelled.
- 46b. They will attract each other as unlike-poles are facing each other.