

NANYANG PRIMARY SCHOOL
SECOND SEMESTRAL EXAMINATION
2007

PRIMARY 3
MATHEMATICS

DURATION: 1 HOUR 45 MINUTES

Section A	/ 40
Section B	/ 40
Section C	/ 20

Total:	/ 100
---------------	--------------

Name: _____ ()

Class: Primary 3 ()

Date: 31 October 2007

Parent's Signature: _____

DO NOT OPEN THIS BOOKLET UNTIL YOU ARE TOLD TO DO SO.

FOLLOW ALL INSTRUCTIONS CAREFULLY.

ANSWER ALL QUESTIONS.

Section A

Questions 1 to 20 carry two marks each. For each question, four choices are given. One of them is the correct answer. Make your choice (1, 2, 3 or 4). Shade the oval (1, 2, 3 or 4) on the Optical Answer Sheet.

(Total: 40 marks)

1. 84 hundreds is the same as _____.

- (1) 8 hundreds and 4 tens
- (2) 8 thousands and 4 ones
- (3) 8 thousands and 4 tens
- (4) 8 thousands and 40 tens

2. What is the value of $\$1.40 + 45¢$?

- (1) \$0.95
- (2) \$1.85
- (3) \$95.00
- (4) \$185.00

3. Andy bought a box of chocolates at \$14 and a pack of candy at \$4.85. If he gave the cashier a 50-dollar note, how much change would he get?

- (1) \$31.15
- (2) \$40.85
- (3) \$59.15
- (4) \$68.85

4. Which of the following is not an equivalent fraction of $\frac{2}{3}$?

- (1) $\frac{4}{6}$
- (2) $\frac{6}{8}$
- (3) $\frac{6}{9}$
- (4) $\frac{8}{12}$

5. A group of pupils made a total of 3018 paper cranes in 3 weeks. If they made 708 paper cranes in the first week and 1265 paper cranes in the second week, how many paper cranes did they make in the third week?

- (1) 1045
- (2) 1065
- (3) 1145
- (4) 1973

6. Express $\frac{12}{15}$ in its simplest form.

(1) $\frac{2}{3}$

(2) $\frac{2}{5}$

(3) $\frac{3}{5}$

(4) $\frac{4}{5}$

7. The graph below shows the number of people who visited a museum on four days.

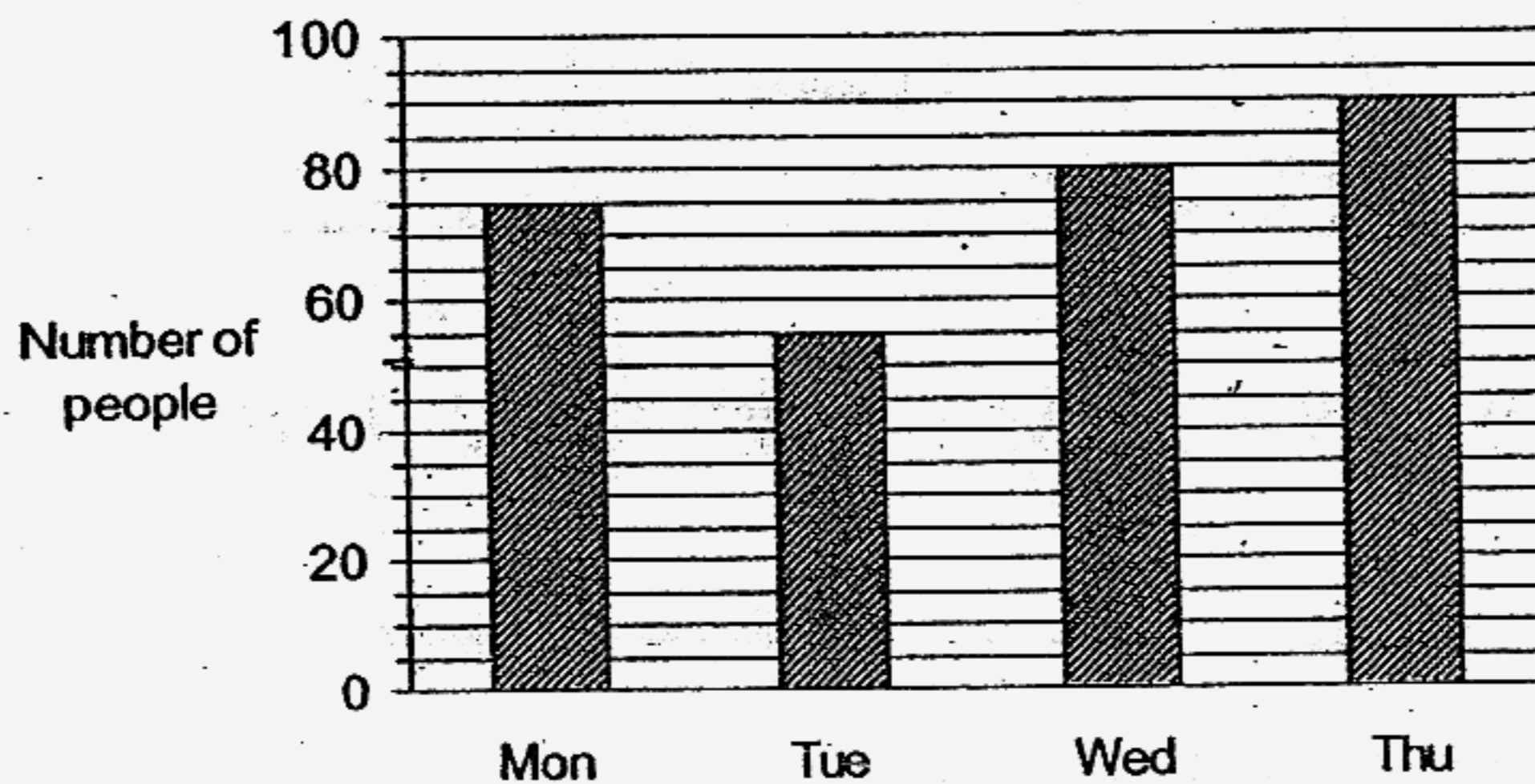

How many people visited the museum on Tuesday?

(1) 43
(3) 55

(2) 50
(4) 58

8. A bottle and a container have a total capacity of $3\frac{1}{5}$ 000 ml. If the container can hold 600 ml more water than the bottle, what is the capacity of the container?

(1) 1450 ml
(3) 2900 ml

(2) 2050 ml
(4) 4100 ml

9. Which of the following figure contains only a pair of parallel lines and 2 pairs of perpendicular lines?

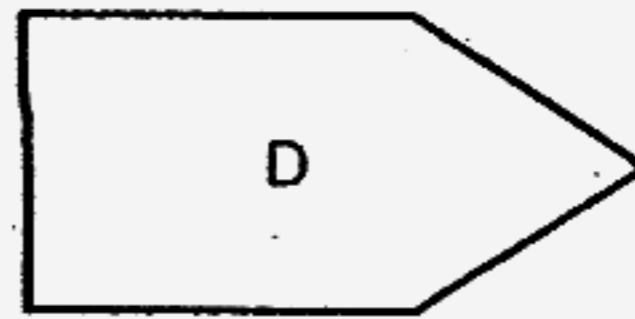
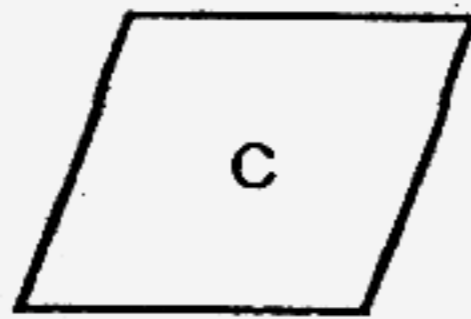
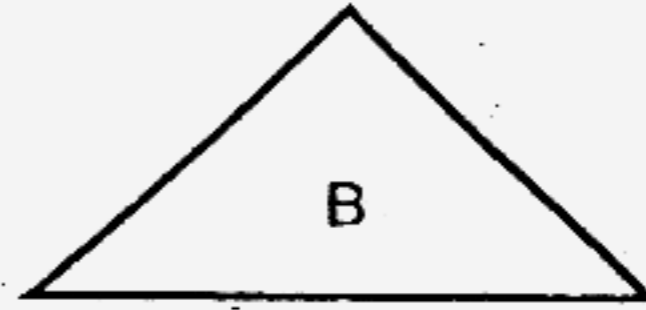
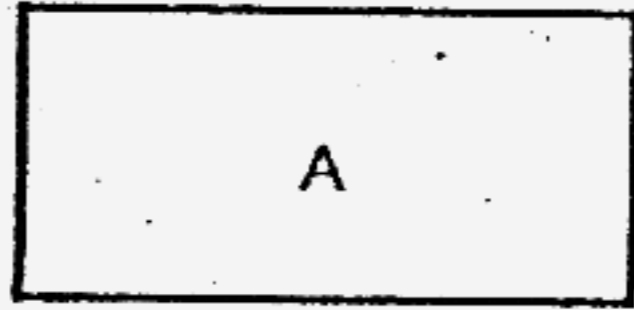

- (1) A
(3) C

- (2) B
(4) D

10. What is the perimeter of the shaded figure below?

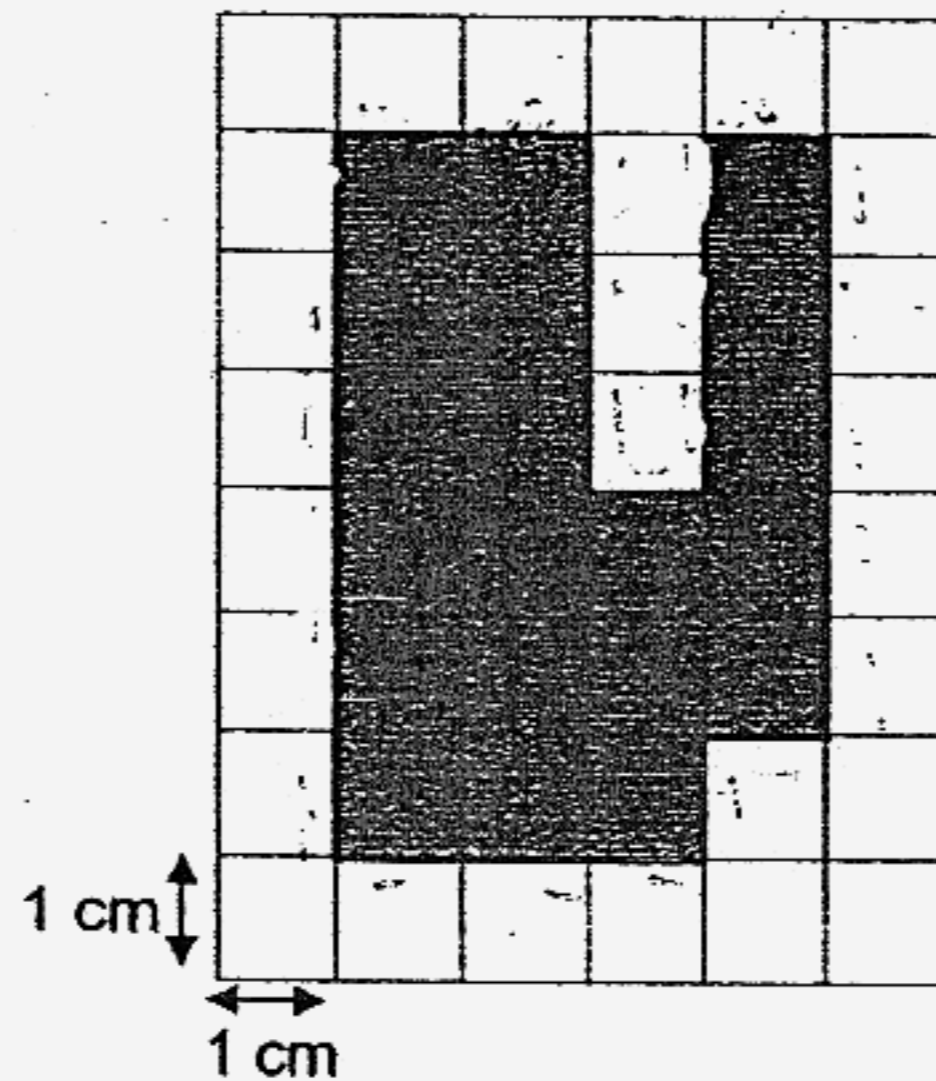

- (1) 20 cm
(3) 26 cm

- (2) 24 cm
(4) 28 cm

11. Mrs Lim sold 9844 cookies in January and 4678 cookies in February. How many more cookies did she sell in January?

- (1) 5166
- (3) 5266

- (2) 5234
- (4) 5276

12. Study the number pattern below.

9, 54, 324, _____, ~~11 644~~

What is the missing number?

- (1) 369
- (3) 1824

- (2) 594
- (4) 1944

13. Zeus had 368 marbles. He gave 48 marbles to Ali and put the rest equally into bags of 8. How many marbles were there in each bag?

- (1) 40
- (3) 46

- (2) 42
- (4) 52

14. Which of the following is 1 cm shorter than 10 m?

- (1) 9 cm
- (3) 999 cm

- (2) 99 cm
- (4) 9999 cm

15. May bought 3 pieces of cloth. The length of the blue and red cloth was 1 m 5 cm each. The green cloth was 70 cm long. What was the total length of the 3 pieces of cloth?

- (1) 220 cm
- (3) 315 cm

- (2) 280 cm
- (4) 370 cm

16. Study the picture below.

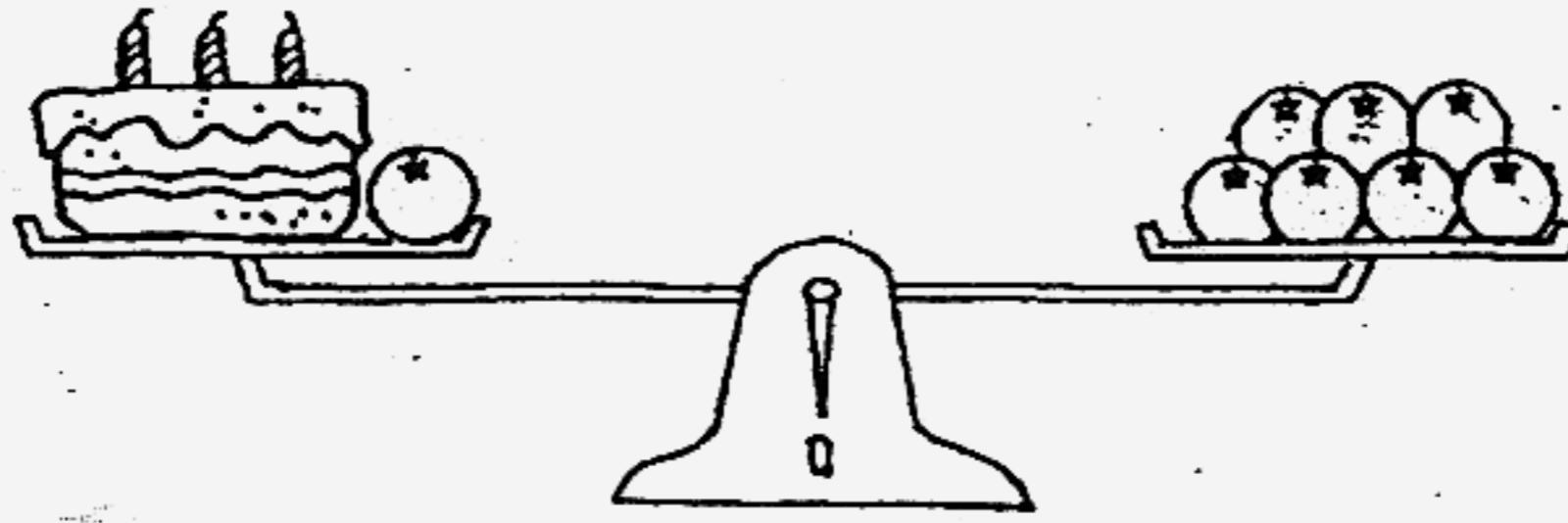

If the mass of each orange is 150 g, what is the mass of the cake?

- | | |
|------------|------------|
| (1) 800 g | (2) 900 g |
| (3) 1050 g | (4) 1200 g |

17. Which of the following clock faces shows the hour hand and minute hand making a right angle?



- | | |
|-------|-------|
| (1) A | (2) B |
| (3) C | (4) D |

Section B

Questions 21 to 40 carry 2 marks each.
Write your answers in the blanks provided.

(Total: 40 marks)

21. Write 5 thousands, 4 tens and 43 ones in figures.

Answer : _____

22. Use all the digits 7, 5, 2 and 0 to form the smallest four-digit even number.

Answer : _____

23. Arrange the following numbers in descending order.

5124 , 5412 , 5214 , 5421

Answer : _____

24. Last year, the library bought 3460 English books and 550 fewer Chinese books than English books. What was the total number of books bought?

Answer : _____

25. What is the missing number in the box?

$$24 \times 7 = 3 \times \square$$

Answer : _____

26. Hubert had 757 sweets. He packed them into bags of 9 sweets. How many sweets were left over?

Answer : _____

27. Express the following sum of money in cents.



Answer : _____¢

28. Ali had \$100. He bought 2 books at \$35.90 each and a calculator at \$15.50. How much money had he left?

Answer : \$__

29. The distance between every 2 lamp posts is 200 m. Calculate the distance between the first and tenth lamp post. Give your answer in km and m.

Answer : _____ km _____ m

30. A jar containing flour weighs 6 kg 459 g. If the flour weighs 3 kg 50 g, what is the mass of the empty jar?

Answer : _____ g

31. To make lemonade, Marie used 850 ml of lemon syrup and twice as much water as the lemon syrup. How much lemonade would Marie get?

Answer : _____ ml

32. Arrange the following fractions in order, beginning with the smallest.

$$\frac{4}{5}, \frac{4}{9}, \frac{4}{7}$$

Answer : _____

33. Which of the following 2 figures have the same number of right angles in them?

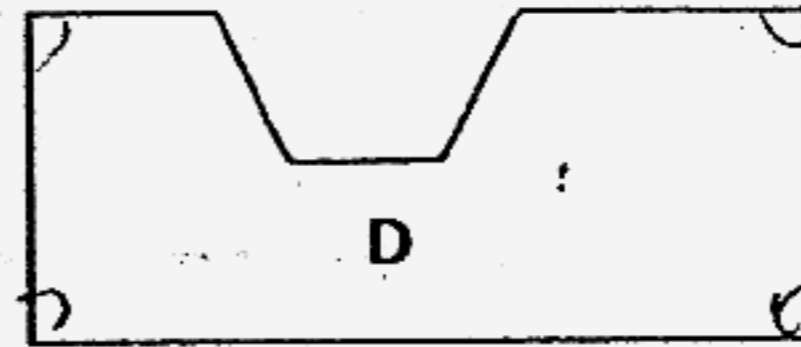
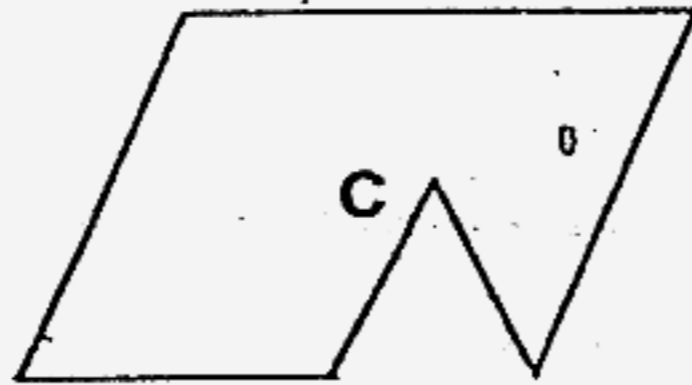
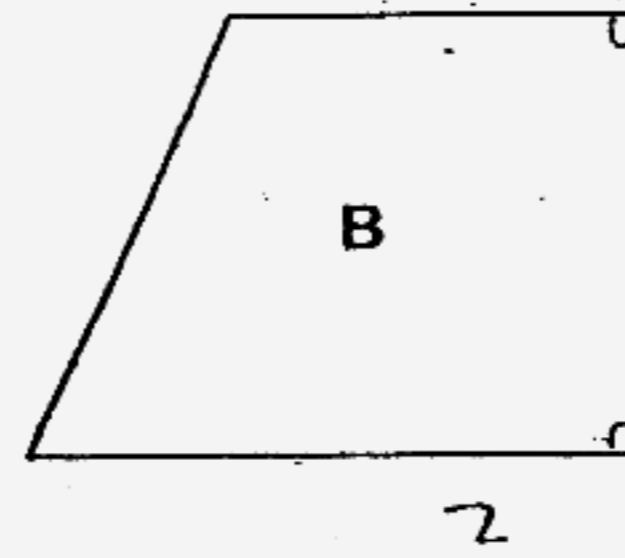
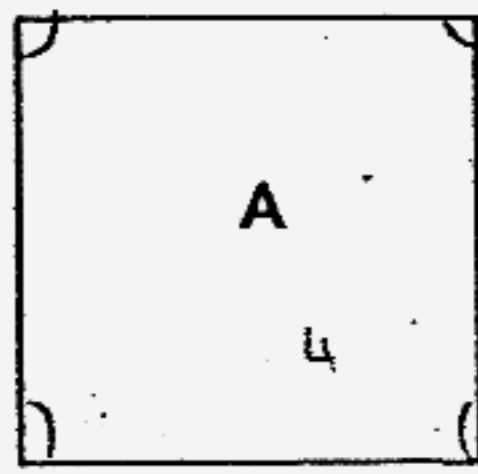

Answer : _____ and _____

34. How many angles are there in the object below?

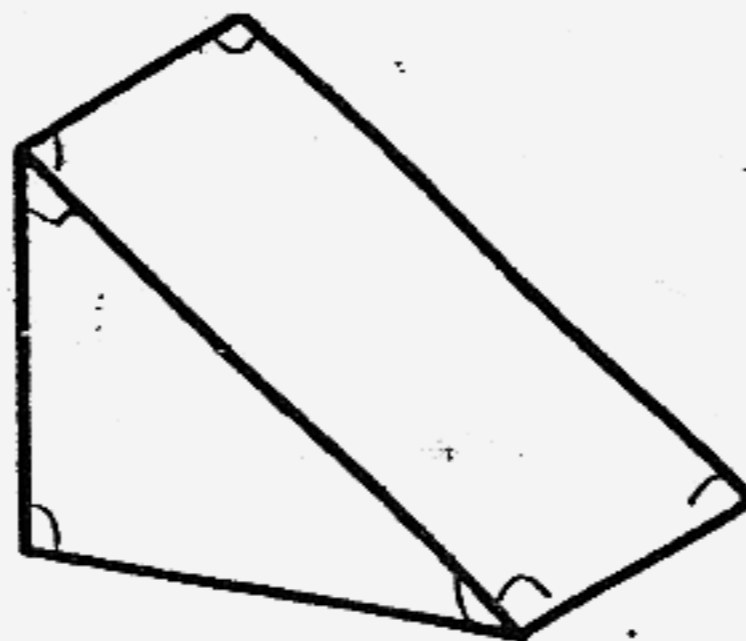

Answer: _____

35. The figure below is made up of Square X and Rectangle Y. Find the perimeter of the figure.

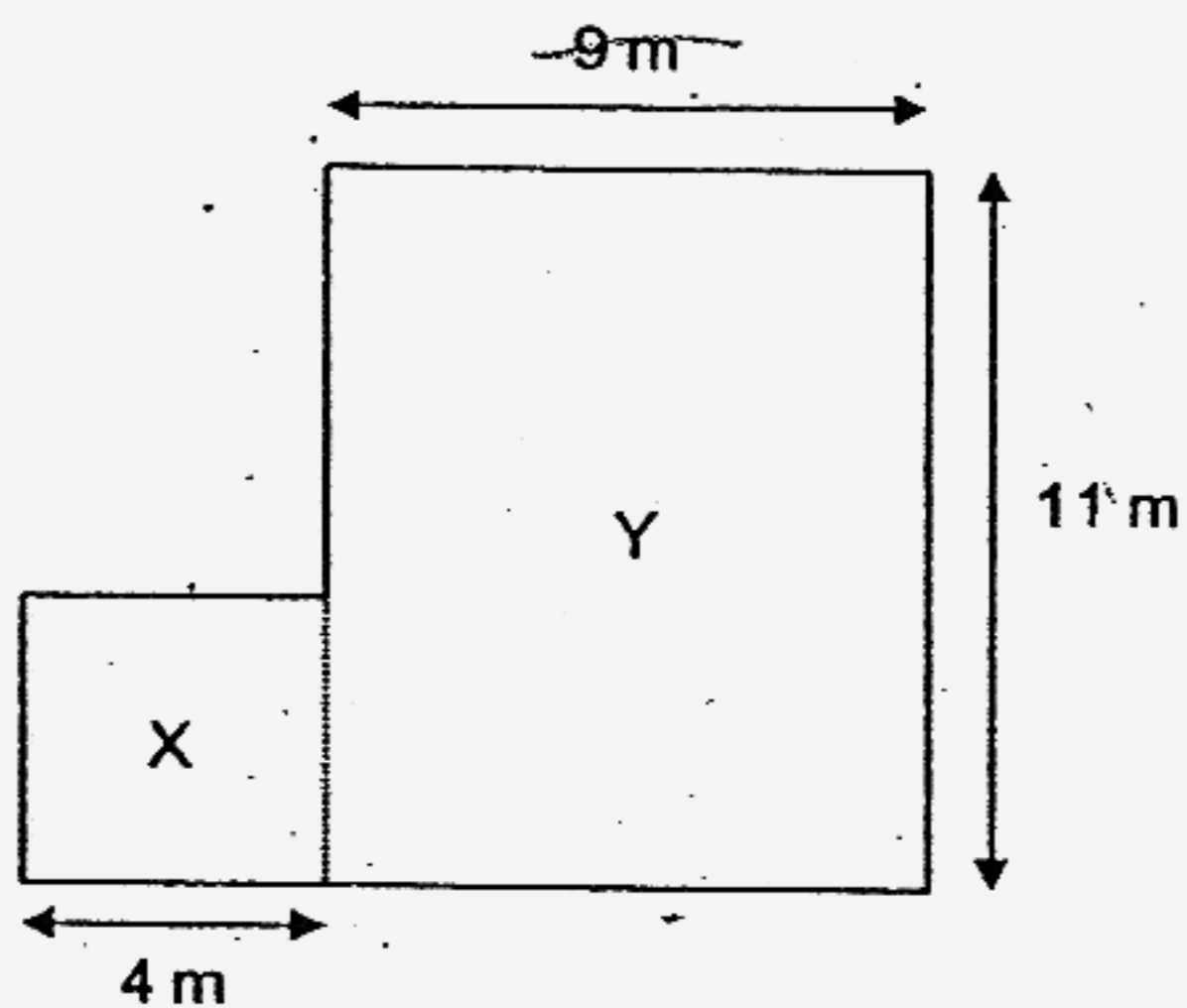

Answer : _____ m

36. Study Figures A and B carefully.

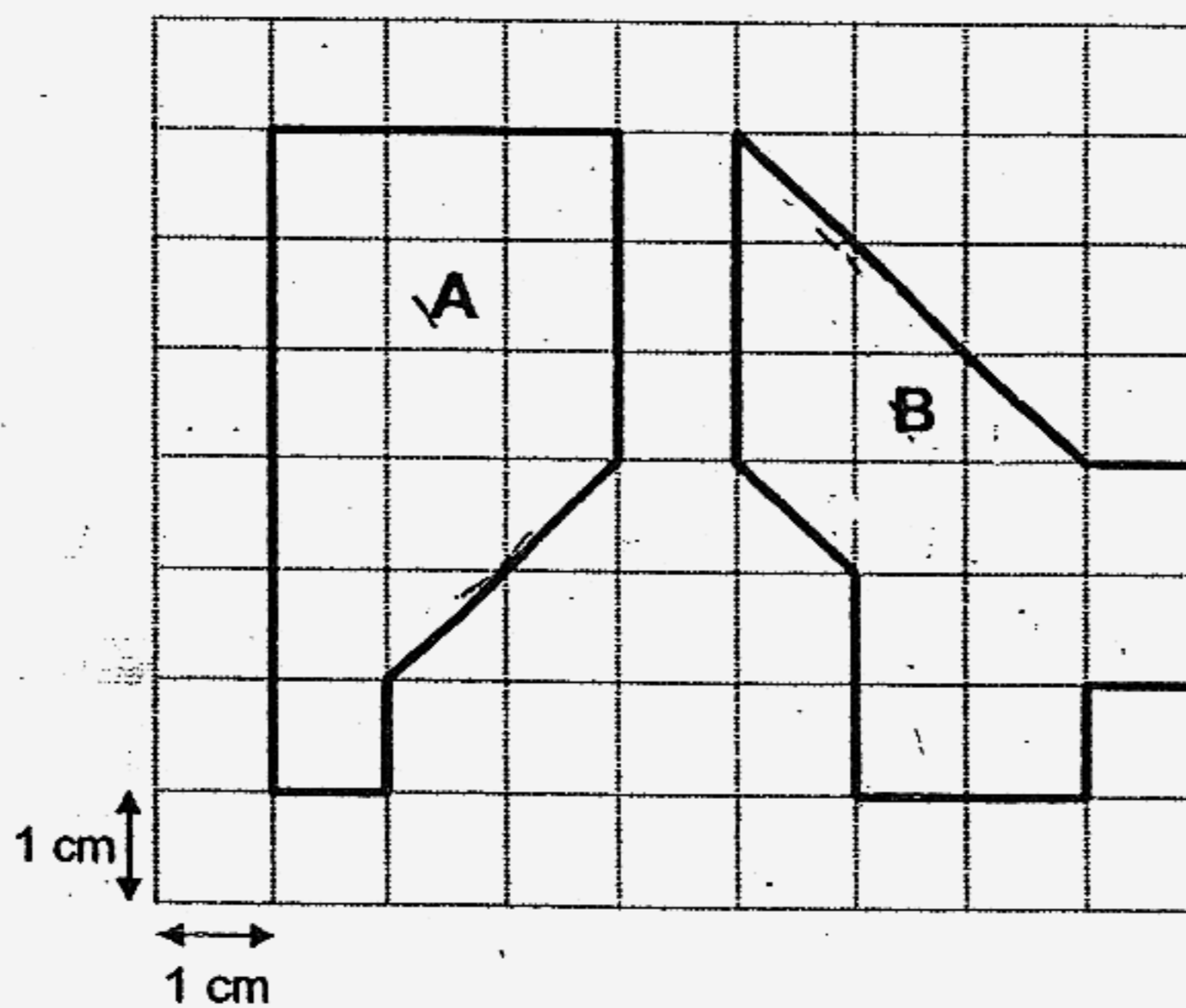

Which figure has a greater area?

Answer : Figure _____

37. Miss Loh had 2136 roses and 6722 tulips in the shop. After selling 3455 tulips, how many more tulips than roses did she have left?

Answer :

38. Subtract $\frac{1}{4}$ from the sum of $\frac{2}{3}$ and $\frac{1}{6}$. Give your answer in its simplest form.

Answer : _____

39. The graph below shows the number of pencil cases sold by 5 girls in a fund raising event.

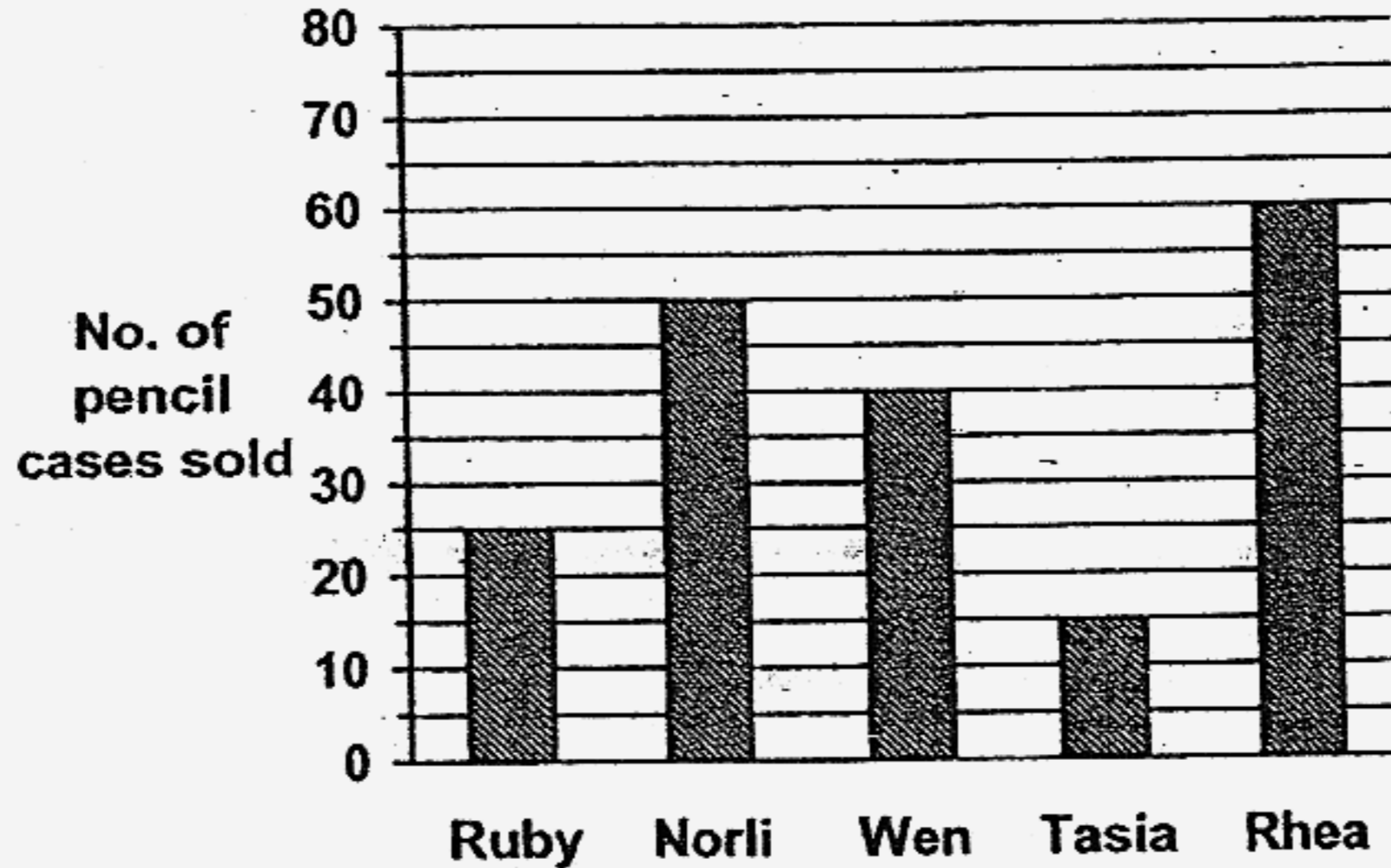

If each pencil case was sold for \$4, how much was collected by Rhea and Tasia altogether?

Answer : \$ _____

40. Figure Q is made up of a rectangle and 2 identical squares. Find the area of Square M if it has the same perimeter as Figure Q.

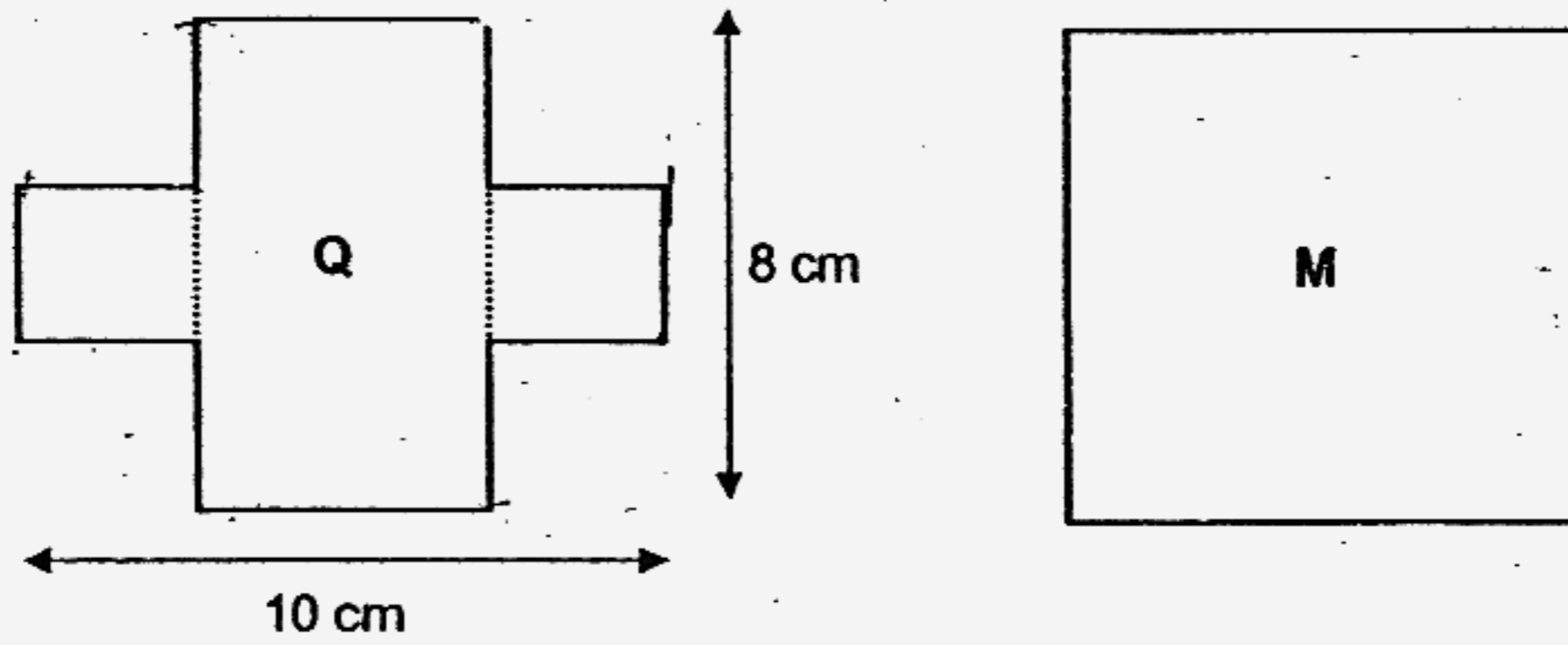

Answer : _____ cm²

Section C

Questions 41 to 45 carry 4 marks each. Do these word problems carefully. Show your working in the space provided.

(Total: 20 marks)

41. Three similar pairs of soccer boots cost \$120. 1 pair of soccer boots and 2 pairs of track shoes cost \$240. How much does 1 pair of soccer boots and 1 pair of track shoes cost in total?

42. Mr Tan spent \$190.60 in a boutique. He bought a shirt, a pair of pants and 2 similar ties. He bought the shirt at \$49.90. If the pair of pants cost \$12.80 more than the shirt, how much was the cost of each tie?

43. At 8.40 a.m., Aryan boarded a train at Town A to travel to Town D. It took him 2 h 15 min to reach Town B. From Town C to Town D, it took him 1 h 5 min.

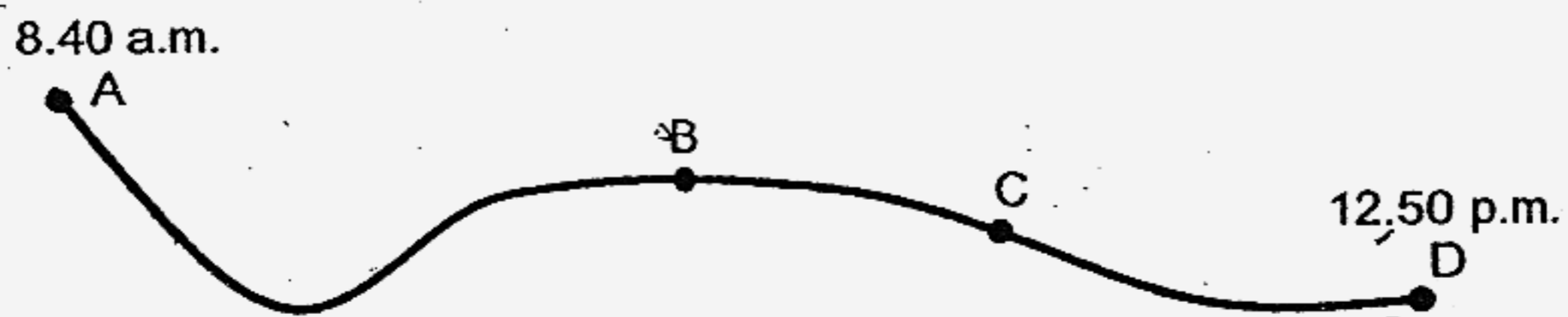

If Aryan reached Town D at 12.50 p.m.,

- what was the total time taken for him to travel from Town A to Town D?
- how long did the train take to travel from Town B, Town C?

44. Jake had 160 more marbles than Ling at first. After Jake gave away 230 marbles, Ling had twice as many marbles as Jake. How many marbles did Jake have at first?

45. Abigail, Benny and Cathy have 550 marbles altogether. Abigail has thrice as many marbles as Benny. Cathy has 40 more marbles than Benny. How many more marbles does Abigail have than Cathy?

☺ *End of Paper* ☺
Please Check Carefully.

Setters:
Mr Azman

**Nanyang Primary School
Primary 3 SA2 Maths Exams (2007)**

Answer Keys

- | | | | | |
|-------|-------|-------|-------|-------|
| 1) 4 | 2) 2 | 3) 1 | 4) 2 | 5) 1 |
| 6) 4 | 7) 3 | 8) 2 | 9) 4 | 10) 3 |
| 11) 1 | 12) 4 | 13) 1 | 14) 3 | 15) 2 |
| 16) 2 | 17) 2 | 18) 4 | 19) 2 | 20) 4 |

21. 5083

22. 2570

23. 5421, 5412, 5214, 5124

24. 6370

25. 56

26. 1

27. 5660

28. \$12.70

29. 1km 800m

30. 3409g

31. 2l 550ml

32. $\frac{4}{9}, \frac{4}{7}, \frac{4}{5}$

33. A and D

34. 18

35. 48m

36. A

37. 1130

38. $\frac{7}{12}$

39. \$300

40. 81cm²

41. $\$120 \div 3 = \40
 $\$240 - \$40 = \$200$
 $\$200 \div 2 = \100
 $\$100 + \$40 = \$140$
It cost \$140.
42. $\$49.90 + \$12.80 = \$62.70$
 $\$62.70 + \$49.90 = \$112.60$
 $\$190.60 - \$112.60 = \$78.00$
 $\$78 \div 2 = \39
Each tie cost \$39.
43. $12.50 - 8.40 = 4\text{hrs } 10\text{mins}$
The total time taken was 4hrs 10mins
 $2\text{hrs } 15\text{mins} + 1\text{hr } 5\text{mins} = 3\text{hrs } 20\text{mins}$
 $4\text{hrs } 10\text{mins} - 3\text{hrs } 20\text{mins} = 50\text{mins}$
It took 50mins to travel from Town B to Town C.
44. $230 - 160 = 70$
 $70 + 230 = 300$
Jake had 300 marbles at first.
45. $550 - 40 = 510$
 $510 \div 5 = 102$
 $102 + 40 = 142$
 $102 \times 3 = 306$
 $306 + 102 + 142 = 550$
 $306 - 142 = 164$
Abigail has 164 more marbles than Cathy.