



AI TONG SCHOOL

2007

SEMESTRAL ASSESSMENT 2

PRIMARY 3

SCIENCE

DURATION : 1 H 30 MIN

DATE : 29 October 2007

INSTRUCTIONS

Do not open the booklet until you are told to do so.
Follow all instructions.
Answer all questions.

Name : _____ ()

Class : Primary 3 _____

Marks:

100

Parent's Signature : _____

Date : _____

Section A (30 x 2 marks)

For each question from 1 to 30, four options are given. One of them is the correct answer. Make your choice (1, 2, 3 or 4). **Shade the correct oval (1, 2, 3 or 4) on the Optical Answer Sheet.**

1. Which one of the following is a characteristic of all living things?

They _____.

- (1) feed on plants
- (2) need sunlight to grow
- (3) can grow from young to adult
- (4) reproduce by giving birth to their young

2. An elephant is a living thing because it _____.

- (1) is big
- (2) is warm
- (3) needs food
- (4) can be seen

3. Why do animals move about?

- A: To look for shelter
- B: To escape from danger
- C: To look for a mating partner

- (1) A only
- (2) A and B only
- (3) B and C only
- (4) A, B and C

4. The following objects are grouped according to their _____.

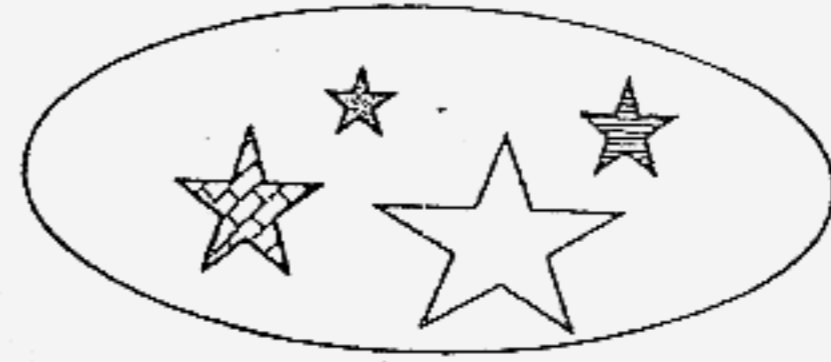
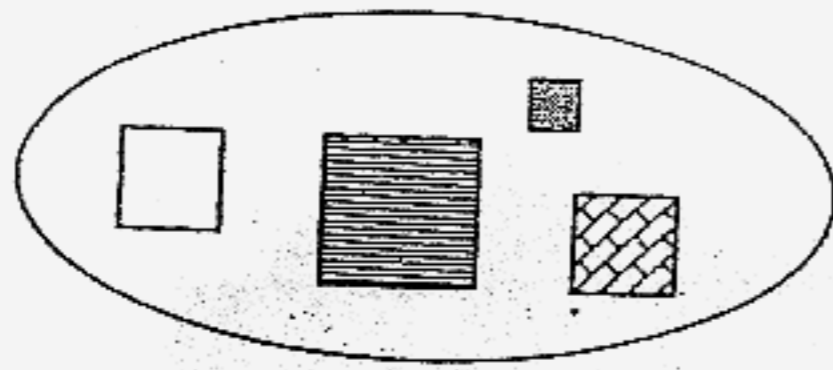

- (1) size
- (2) shape
- (3) colour
- (4) texture

5. The classification table below shows how some animals are grouped.

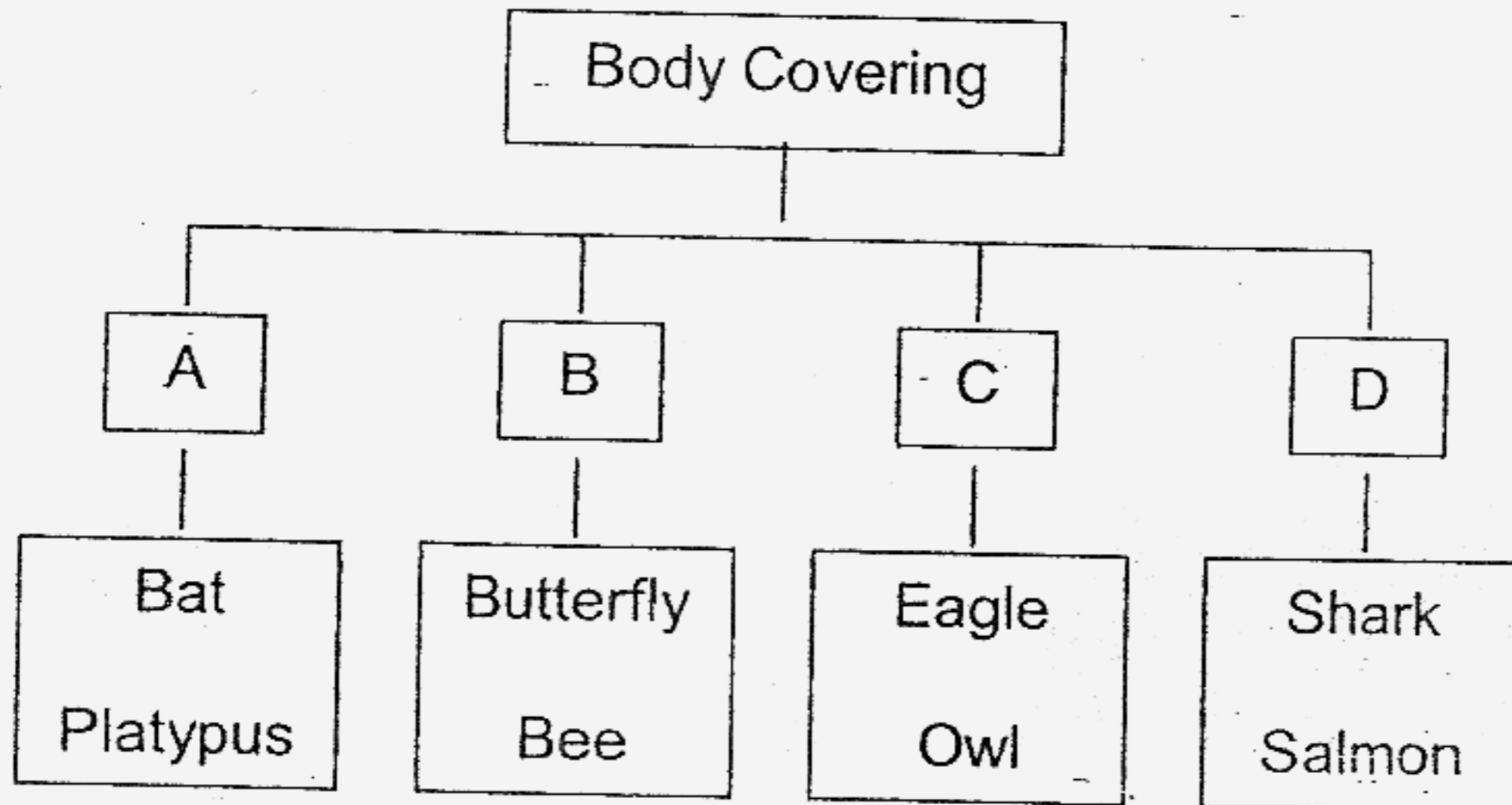

A penguin should be put in Group _____.

- (1) A
- (2) B
- (3) C
- (4) D

6. The picture below shows a fish.

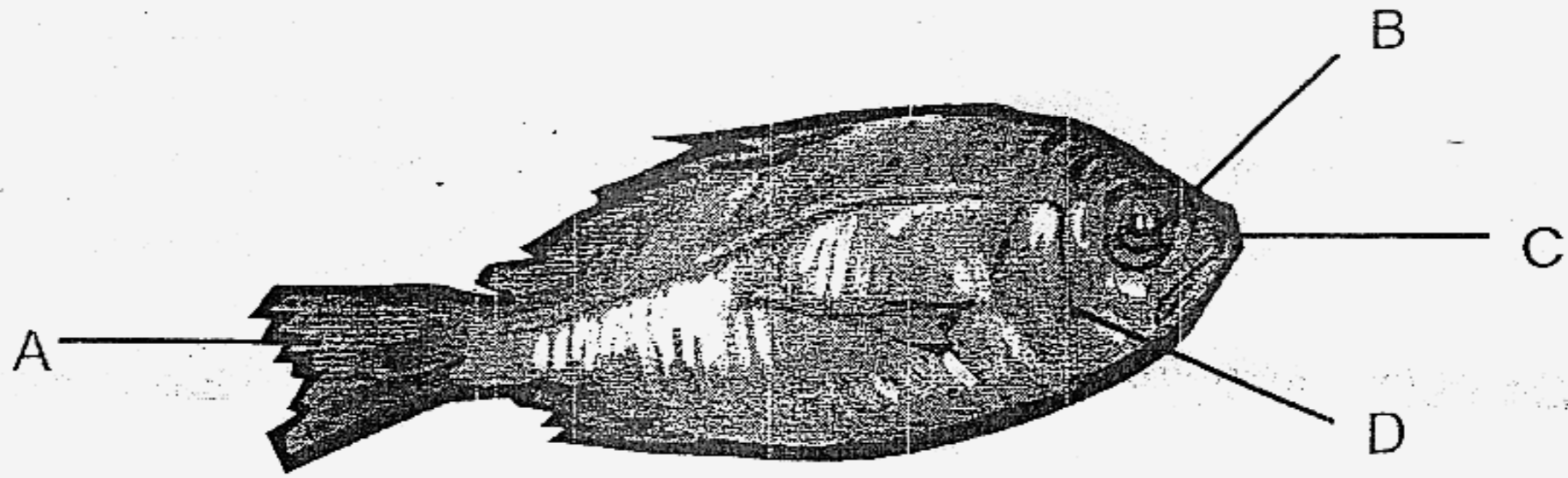

The part labelled _____ helps the fish to swim.

- (1) A
- (2) B
- (3) C
- (4) D

7. Which group of animals eats only plants?

- (1) Cat, goose, spider
- (2) Horse, panda, crow
- (3) Snail, beetle, eagle
- (4) Caterpillar, grasshopper, zebra

8. Which one of the following statements about chlorophyll is false?

- (1) It helps the plant to make food.
- (2) It makes leaves green in colour.
- (3) It is only found in flowering plants.
- (4) It makes plants different from animals.

9. Joey went to the school garden and made a sketch of a mushroom as shown below.



Which of the following statements describe the mushroom correctly?

- A: It makes its own food.
- /B: It reproduces by spores.
- /C: It is a living thing.
- D: It bears flowers and fruits.

- (1) A only
- (2) A and B only
- (3) B and C only
- (4) A, B, C and D only

10. A piece of bread was left in the kitchen. After a few days, tiny black spots labelled X were formed as shown in the picture below.

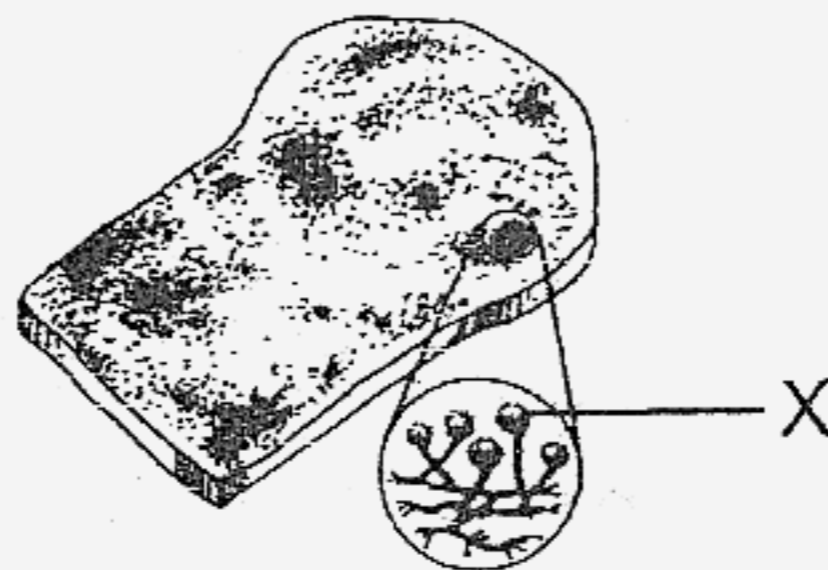

Which of the following statements describe X correctly?

- A: They are edible.
- B: They are small and light.
- C: They help in the reproduction of the organisms.

- (1) A only
- (2) A and B only
- (3) B and C only
- (4) A, B and C

11. The table below shows how some living things can be classified. Which of the organisms are grouped **correctly**?

Fungi	Micro-organisms	Plants
(1) Mould	Bacteria	Bird's nest fern
(2) Cattail	Yeast	Rose plant
(3) Arrowhead	Mould	Jew's ear
(4) Puff ball	Moss	Yeast

12. The _____ is made of only one material.



- (1) pen
- (2) towel
- (3) pencil
- (4) pair of spectacles

13. Which one of the following statements is **true**?

- (1) Both mosquitoes and mealworm beetles have a three-stage life cycle.
- (2) During the pupa stage of a caterpillar, it feeds a lot and grows very quickly.
- (3) The young of a frog looks very much like its parents.
- (4) In the life cycle of a butterfly, each stage looks different from the other.

14. The pictures below show two animals.

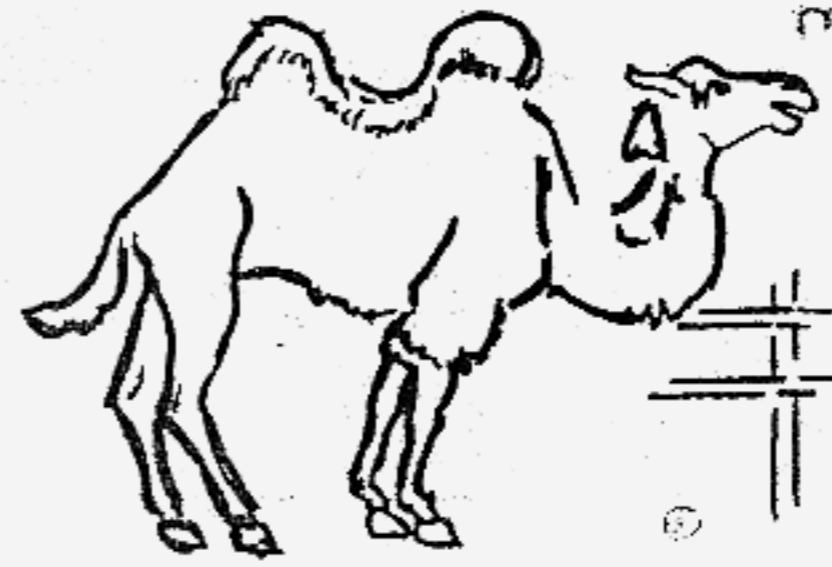
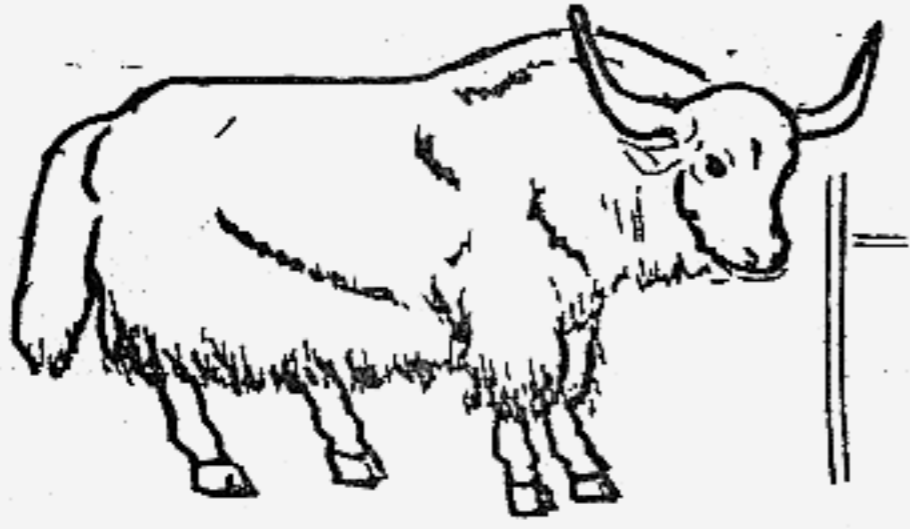

Which one of the following statements describes both the animals?

- (1) Both have horns.
- (2) Both have hooves.
- (3) Both have long necks.
- (4) Both have humps.

15. The picture shows a kitten.



Kitten

Which two cats below are most likely its parents?



A



B



C



D

- (1) A and B
- (2) A and C
- (3) B and C
- (4) C and D

16. The picture shows an egg.

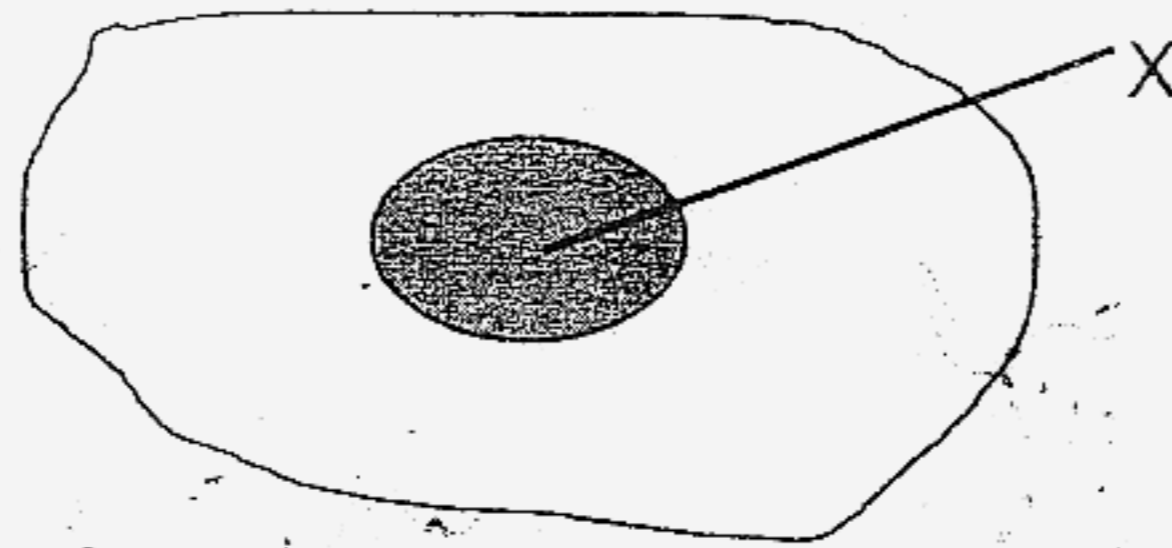

The part labelled X _____

- (1) will develop into a chick
- (2) provides the developing chick with food
- (3) provides air for the developing chick
- (4) protects the egg from its enemies

17. Renee left a potted plant in a dark room for a week as shown below.

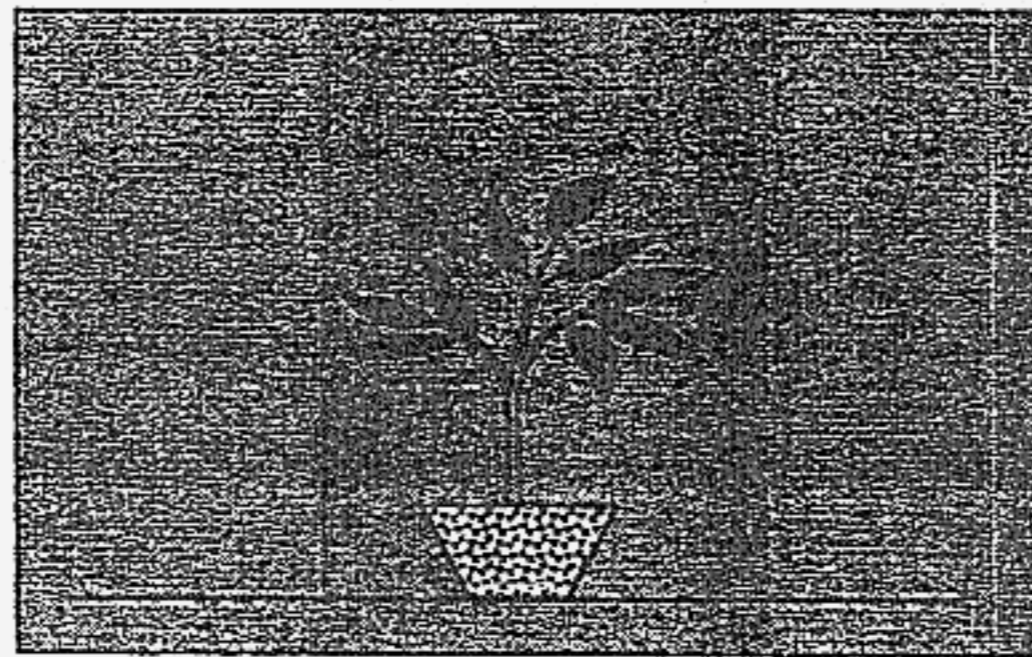

At the end of the week, Renee found the plant dead. The plant was not able to survive because it _____

- (1) had no warmth
- (2) could not make food
- (3) did not have enough air
- (4) did not have fertilizers

18. Terrence collected two leaves from the garden and made a sketch of them as shown below.

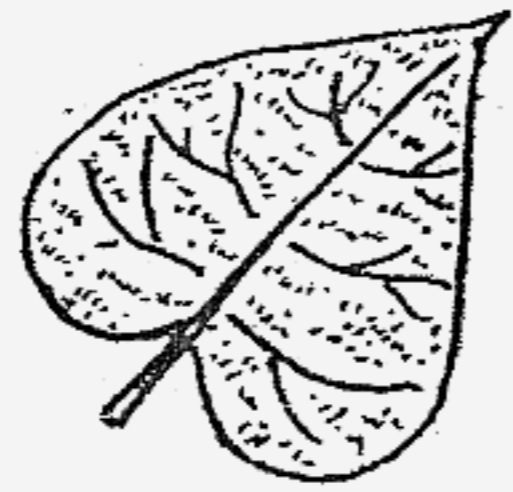

A



B

How are Leaf A and Leaf B similar?

- (1) They have entire edge.
 - (2) They are oval-shaped.
 - (3) They have no leaf veins.
 - (4) Their leaf stalks are of the same length.
19. What will happen to the plant if the part labelled X is missing?

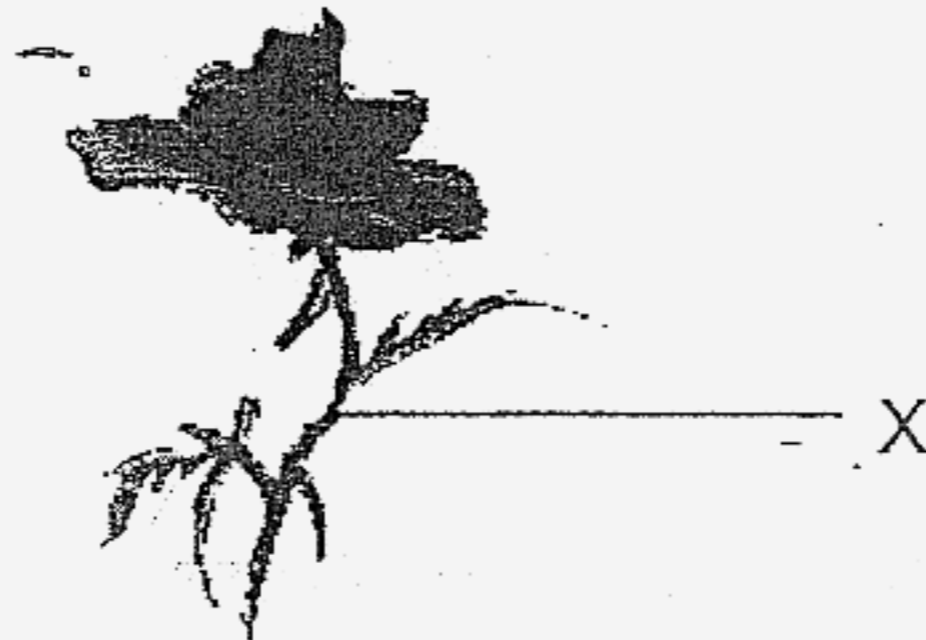

- (1) There will be no seeds.
- (2) There will be no sweet smell.
- (3) The plants cannot be held firmly to the ground.
- (4) Water, food and mineral salts cannot be transported to all parts of the plant.

20. Mary noticed that there are raised dots on the buttons in the lift.

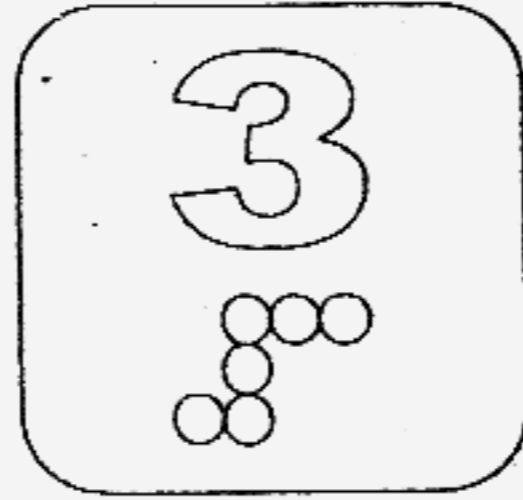

These dots help the blind to tell the number by using their sense of _____.

- (1) sight
- (2) taste
- (3) touch
- (4) hearing

21. The human digestive system is made up of the _____.

- A: lips
- / B: stomach
- / C: small intestine
- / D: anus

- (1) B and C only
- (2) A, B and C only
- (3) B, C and D only
- (4) A, B, C and D

22. The function of the muscular system is to _____.

- (1) support the body
- (2) give the body shape
- (3) help different parts of the body move
- (4) carry waste materials away from different parts of the body

23. Which one of the actions below involves the use of a joint?

- (1) Smiling
- (2) Writing
- (3) Frowning
- (4) Sticking out your tongue

24. The classification chart below shows how some parts of the skeletal system are classified. Which are the possible headings for the different groups?

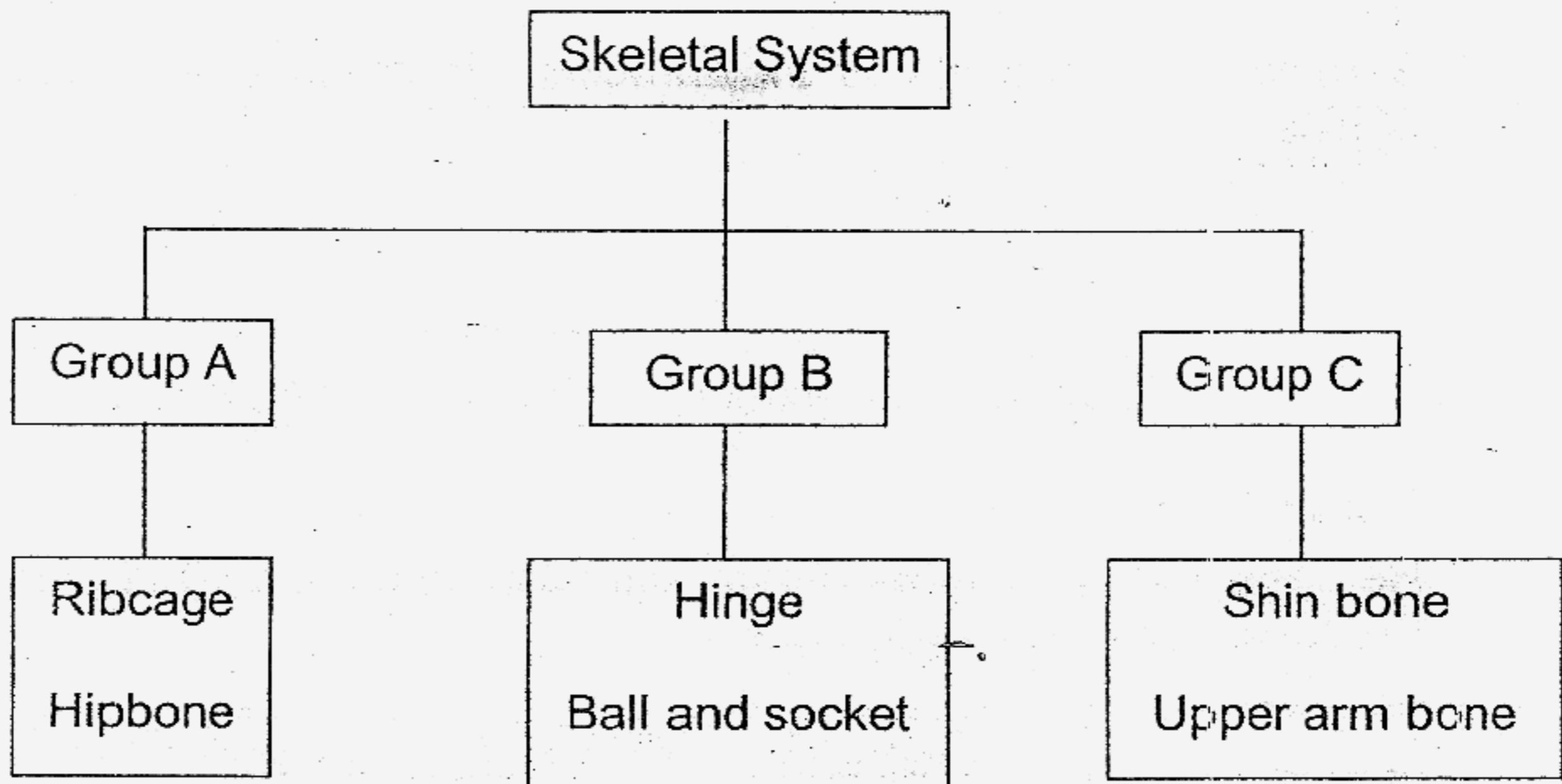

	Group A	Group B	Group C
(1)	Curved bones	Joints	Straight bones
(2)	Curved bones	Muscles	Straight bones
(3)	Straight bones	Joints	Curved bones
(4)	Muscles	Curved bones	Joints

25. Clay is most suitable for making _____.

- (1) toys
- (2) books
- (3) cupboards
- (4) flower pots

26. The table below shows the properties and uses of four different materials. Which material does not match its property and use?

Materials	Properties	Uses
(1) Wood	Hard	Furniture
(2) Rubber	Flexible	Eraser
(3) Glass	Breaks easily	Ruler
(4) Cloth	Light	Curtain

27. Sam had four magnets as shown below. He brought them close to a box of pins.

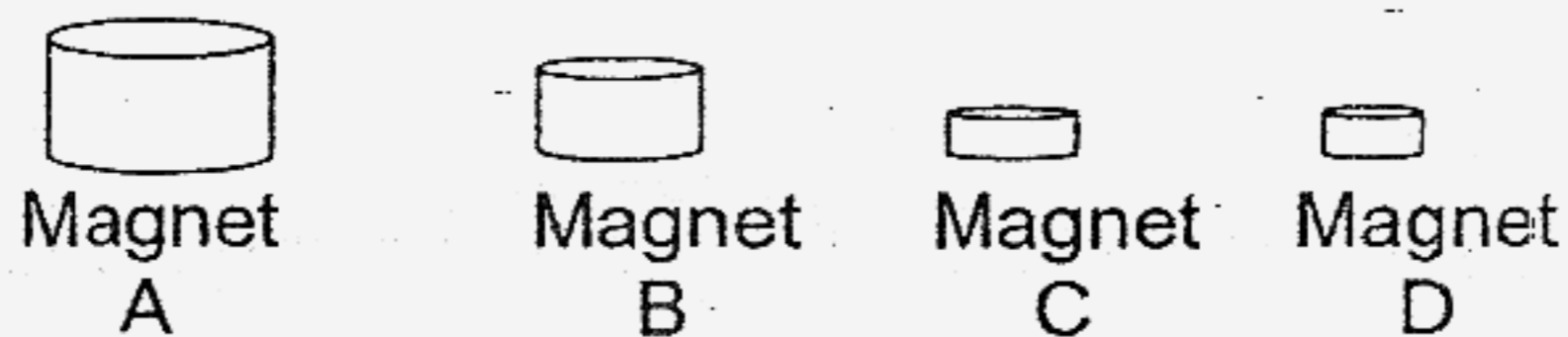

He observed the number of pins attracted by each magnet and tabulated the results in the following table.

	Magnet A	Magnet B	Magnet C	Magnet D
No. of pins attracted	25	30	20	40

From the results in the table, Sam learnt that _____.

- (1) bigger magnets are weaker than smaller magnets
- (2) smaller magnets are weaker than bigger magnets
- (3) the strength of a magnet depends on its size
- (4) the strength of a magnet does not depend on its size

28. A boy wants to find out if magnetism can pass through some materials. He sets up an experiment as shown below.

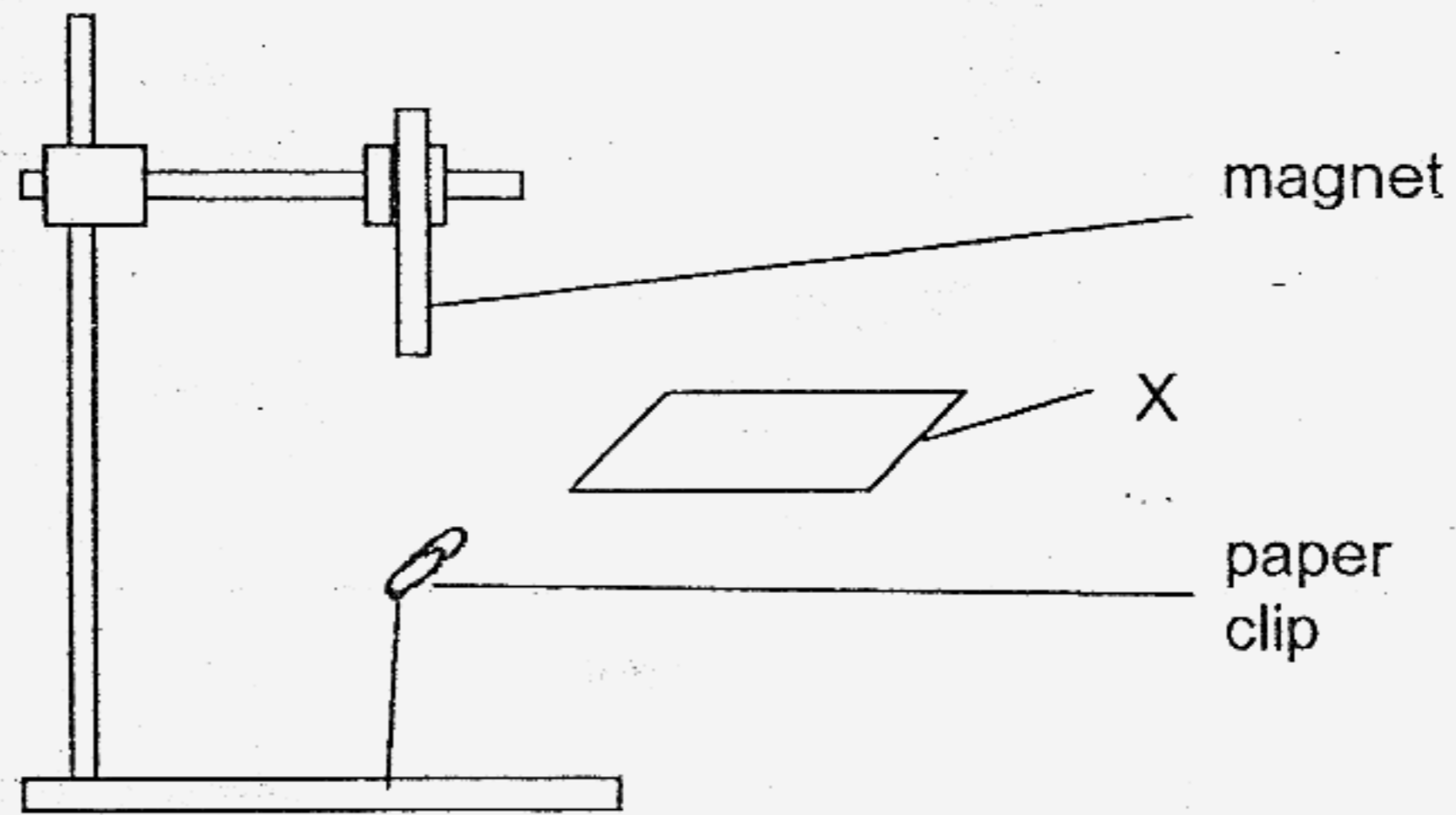

When he puts material X between the paper clip and the magnet, the paper clip dropped. What is material X?

- (1) A sheet of iron
- (2) A sheet of paper
- (3) A sheet of plastic
- (4) A sheet of rubber

29. Magnet E was hung from a spring as shown in Diagram 1. Magnet F was then placed on the table directly below Magnet E as shown in Diagram 2.

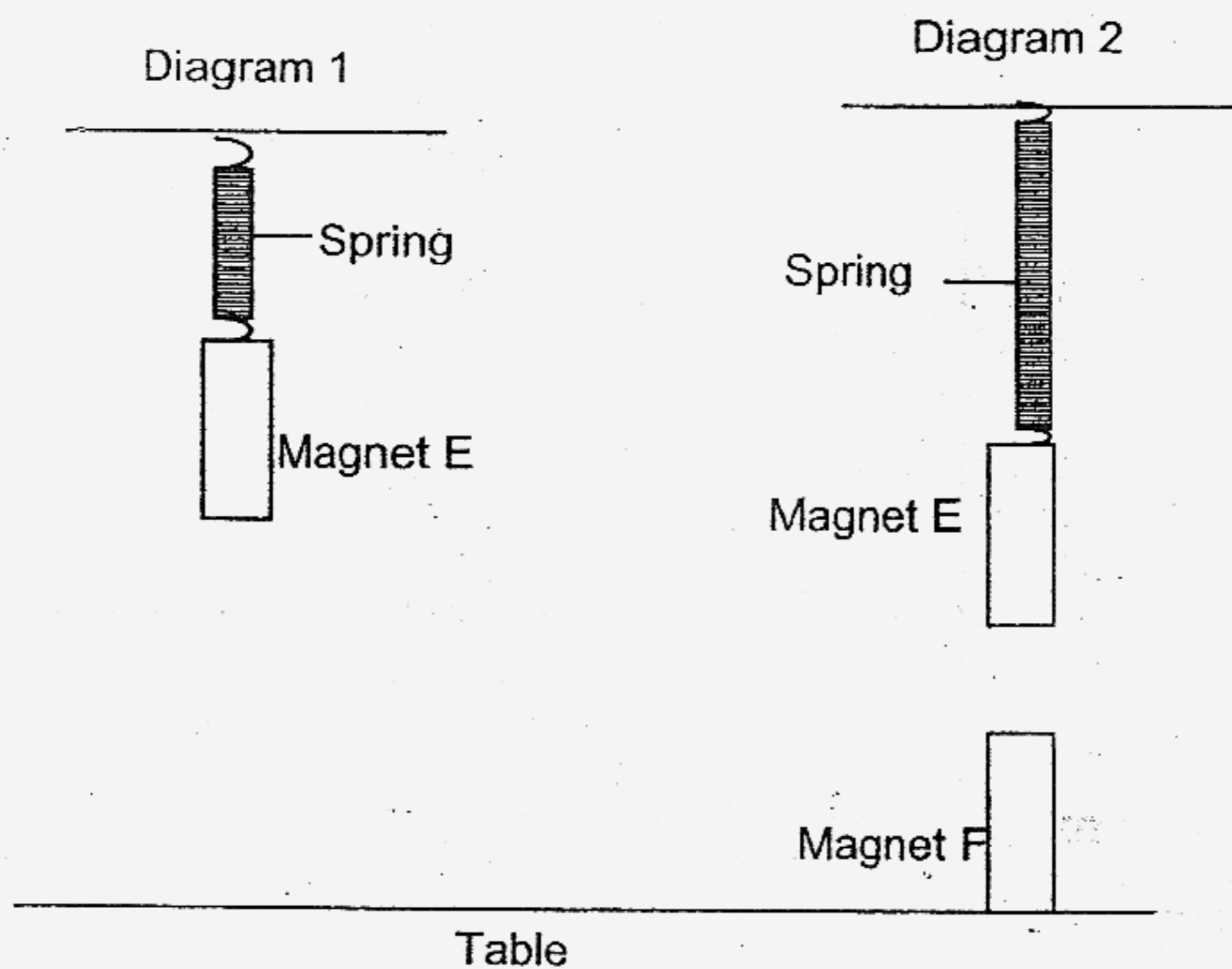

Why did the spring become longer in the set up shown in Diagram 2?

- (1) Magnet F became stronger.
- (2) Magnet F repelled Magnet E.
- (3) Magnet E became weaker.
- (4) Magnet F attracted Magnet E.

30. Peter placed a button magnet near the north-pole of a bar magnet as shown below.



What would he observe?

- (1) The button magnet would move towards the bar magnet.
- (2) The button magnet would move away from the bar magnet.
- (3) The button magnet remains in the same position.
- (4) The bar magnet would move away from the button magnet.

P3 Semestral Assessment 2 (2007)

Name: _____ ()

Class: _____

Section B: (20 marks)

Fill in the blanks with the correct answers. Use each word ONCE only.

spores	rocks	chlorophyll	north-south	homes
warmth	living things	iron	sunlight	photosynthesis
man-made	flowers	batteries	seeds	natural

31. _____ can be classified into plants, animals, micro-organism and fungi.

32. Fruits develop from _____.

33. Plastic is a _____ material produced from crude oil.

34. Stones, sand and clay come from _____.

35. Non-flowering plants reproduce from _____.

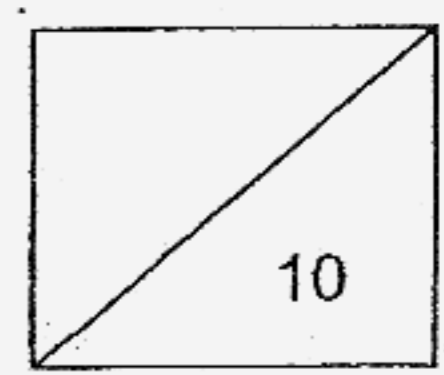

36. For germination to take place, a tomato seed needs air, water and

37. A freely-turning magnet always comes to rest in the

_____ direction.

38. The strength of an electromagnet can be increased with the use of more

39. Steel and _____ objects can be picked up by an

electromagnet.

40. Plants make food in a process called _____

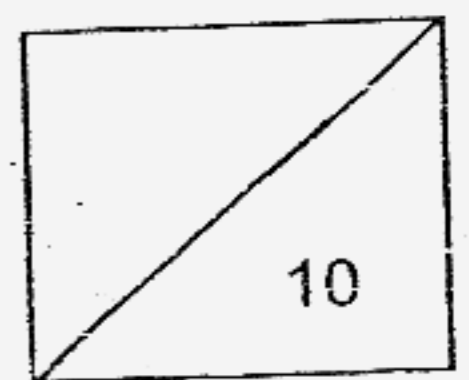

Section C: Open-ended Questions (20 marks)

Write your answers to questions 41 to 45 in the spaces provided.

41. Sort these plants into two groups according to the classification chart below. [4]

water lily	jasmine	ladder fern	bougainvillea
moss	cattail	papaya	maidenhair fern

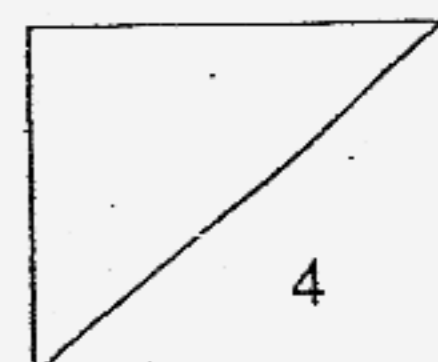
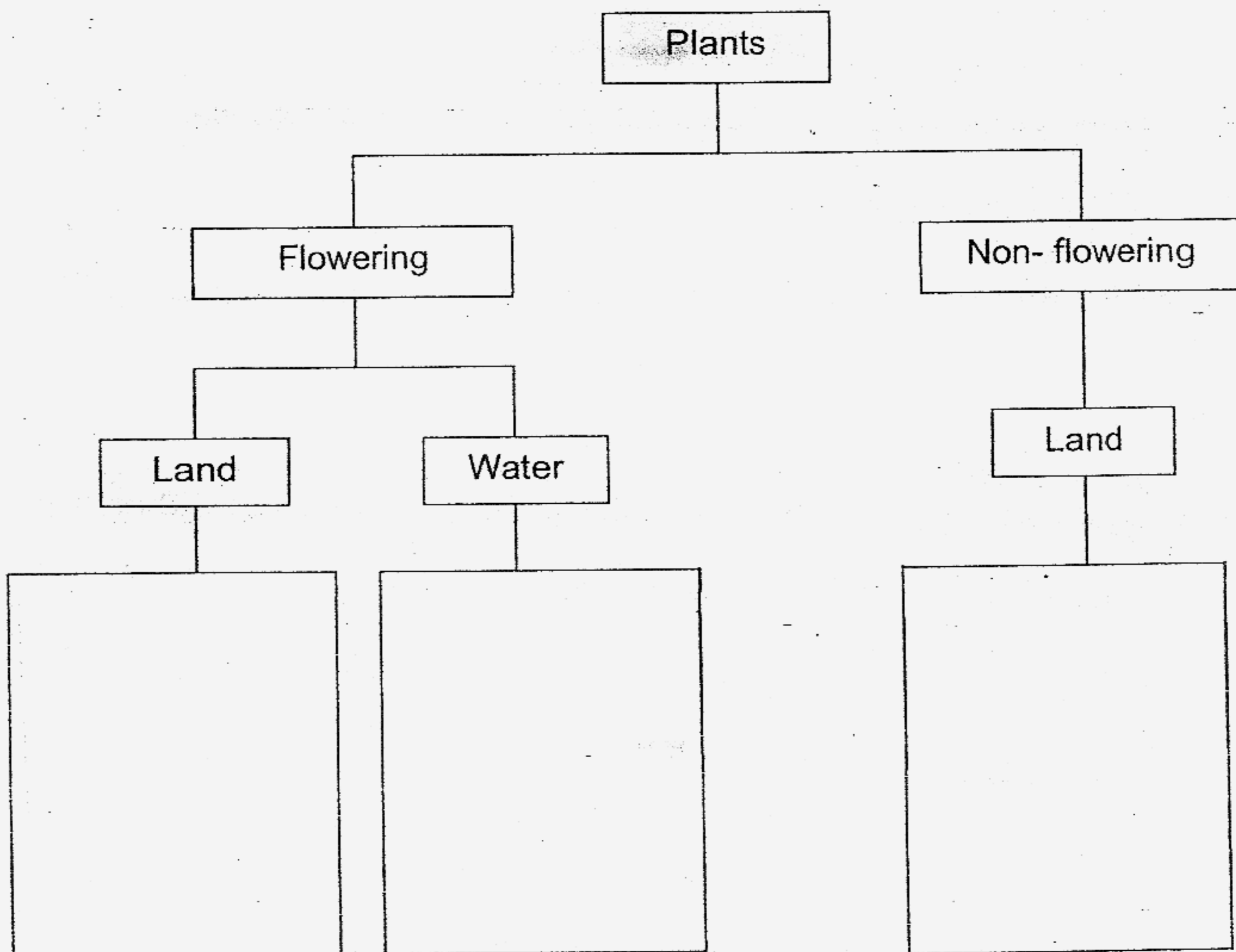

42. Lily bought a pet bird and put it into a cage.

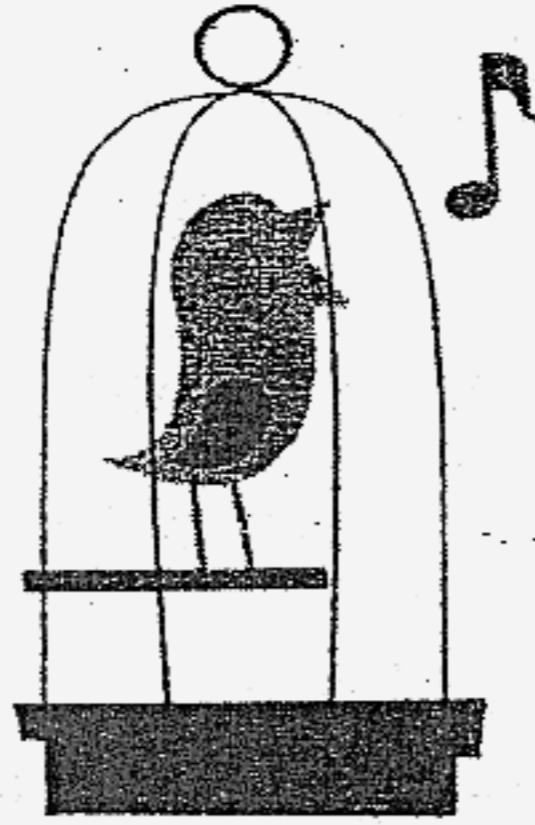

- (a) What are the things Lily should put into the cage to ensure that the bird stays alive?

_____ [2]

- (b) When Lily tried to catch the bird with her hands, it flew away. Which two characteristics of living things was the bird showing?

(i) _____ [1]

(ii) _____ [1]

43. The table below shows 4 objects and the properties of the materials used to make them.

Object	Bag	Toothpick	Handkerchief	Window panes
Flexible	Yes	No	Yes	No
Absorbs water	No	Yes	Yes	No
Can see through	Yes	No	No	Yes
Light	No	Yes	Yes	No

State the material that can be used to make the following objects by referring to the properties in the table:

- (a) Bag : _____ [1]
- (b) Toothpick : _____ [1]
- (c) Handkerchief : _____ [1]
- (d) Window panes: _____ [1]

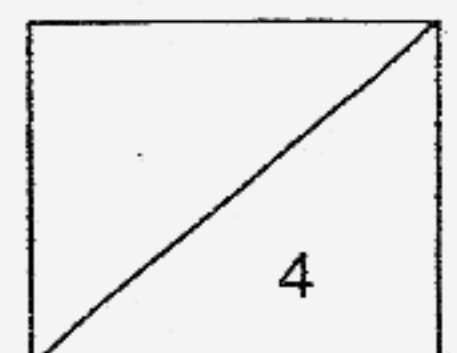

44. (a) Classify the following animals into the correct life-cycle stage in the table below. [2]

cockroach	mosquito	chicken	butterfly
-----------	----------	---------	-----------

Three-stage life cycle	Four-stage life cycle

(b) Draw the diagrams to represent the life cycles of the chicken and butterfly in the boxes provided below. [2]

i)

Life cycle of a chicken

ii)

Life cycle of a butterfly

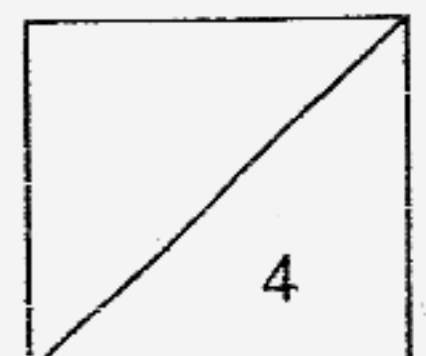

45. (a) The statements below describe how our digestive system works.

[2]

A: The food is crushed and mixed with other digestive juices in the stomach.

B: The food goes into the small intestine.

C: The teeth help to grind the food and the saliva helps to digest the food slightly.

D: The food moves down the gullet into the stomach.

E: The undigested food goes into the large intestine and then passed out through the anus.

F: The very tiny bits of food pass into the blood vessels.

Arrange them in order starting with 'C' and ending with 'E'.

[2]

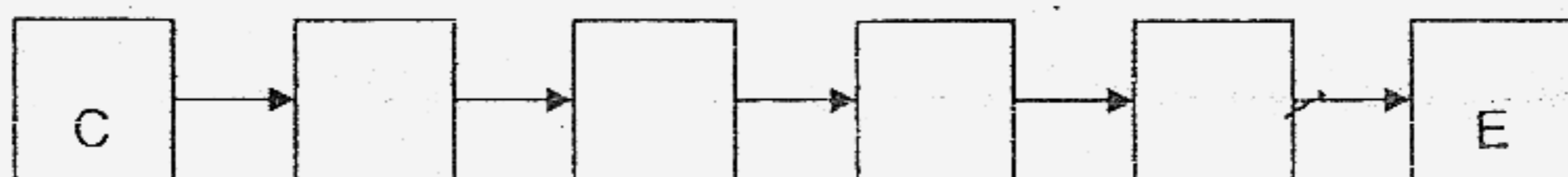

(b) Name 2 parts of the digestive system where digestive juices can be found.

(i) _____ [1]

(ii) _____ [1]

----- Have you checked your work? -----

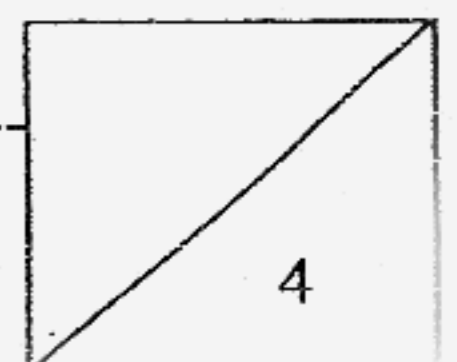

44a.

Three stage life cycles

Chicken
cockroach

Four stage life cycles

Mosquito
Butterfly

44b (i)

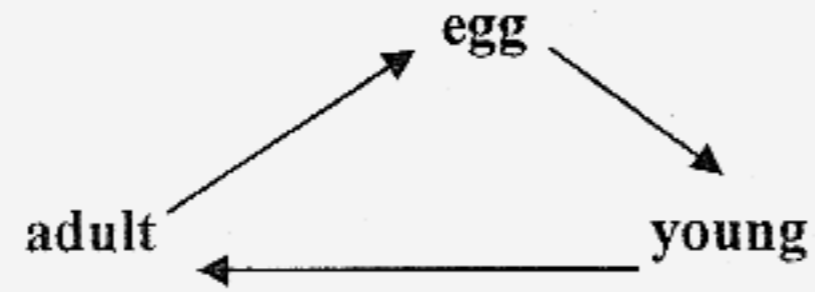

44b (ii)

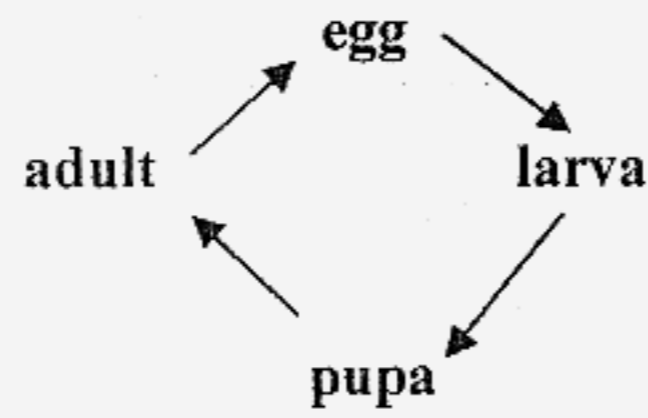

45a. C → D → A → F → E

45b (i). small intestine

(ii). stomach