

Founded 1947

南侨小学

NAN CHIAU PRIMARY SCHOOL

SEMESTRAL ASSESSMENT 1

2007

MATHEMATICS

PRIMARY 2

Name: _____ ()

Marks:

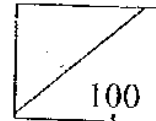

Class: Pr 2 _____

Time: 1 hour 30 min

Date: 7 May 2007

Parent's Signature: _____

Instructions to Pupils:

1. Do **NOT** open this booklet until you are told to do so.
2. Follow all instructions carefully.
3. Answer all questions.

*This paper consists of **18** pages altogether.

Setter: Miss, Eliasarah

Section A: (20 x 2m = 40m)

For each question, four options (1, 2, 3 and 4) are given. Choose the correct answer and write its number in the bracket provided.

1. The number that comes between 299 and 301 is _____.

(1) 298

(2) 300

(3) 302

(4) 400

()

2. The digit '8' in 847 stands for _____.

(1) 8000

(2) 800

(3) 80

(4) 8

()

3. 120 more than 454 is _____.

(1) 334

(2) 474

(3) 534

(4) 574

()

4. $234 + 512 = \underline{\hspace{2cm}}$

(1) 278

(2) 322

(3) 746

(4) 822

()

5. The length of my Math textbook is about $\underline{\hspace{2cm}}$ cm.

(1) 5

(2) 2

(3) 30

(4) 90

()

6. $3 + 3 + 3 + 3 = \underline{\hspace{2cm}} \times 3$

(1) 15

(2) 5

(3) 3

(4) 4

()

7. $7 \times 2 = \underline{\hspace{2cm}}$

(1) 5

(2) 9

(3) 12

(4) 14

()

8. Divide 12 stars into 3 equal groups.

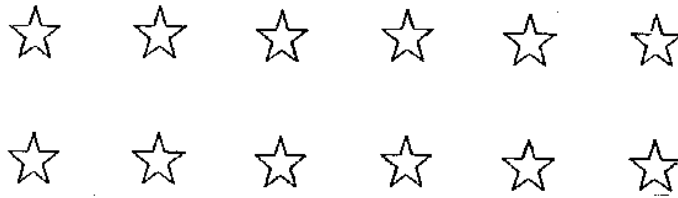

There are _____ stars in each group.

- (1) 15
- (2) 12
- (3) 3
- (4) 4

()

9. The carton of milk has a mass of _____ g.

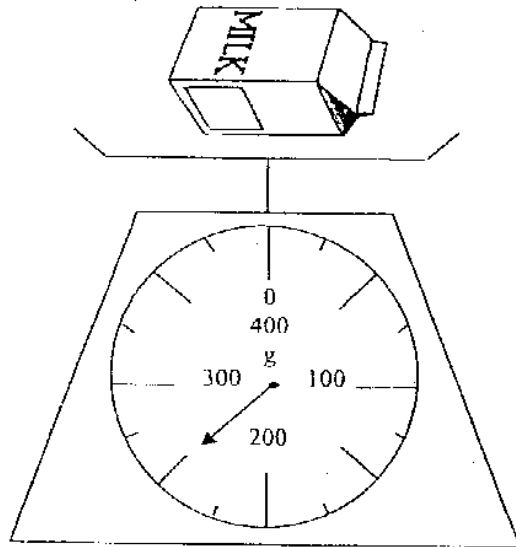

- (1) 220
- (2) 240
- (3) 250
- (4) 260

()

10. $300 - \underline{\hspace{2cm}} = 270$

- (1) 10
- (2) 20
- (3) 30
- (4) 40

()

11. What is the missing digit in the box?

$$\begin{array}{r} 418 \\ + 1\boxed{8} \\ \hline 616 \end{array}$$

- (1) 9
- (2) 8
- (3) 3
- (4) 0

()

12. What is the missing number?

9 , 12 , , 18 , 21

- (1) 13
- (2) 15
- (3) 16
- (4) 17

()

13. Sherry baked 18 cupcakes. She put them equally into 3 boxes.
How many cupcakes were there in each box?

- (1) 6
- (2) 9
- (3) 15
- (4) 21

()

14. The eraser is about _____ cm shorter than the pen.

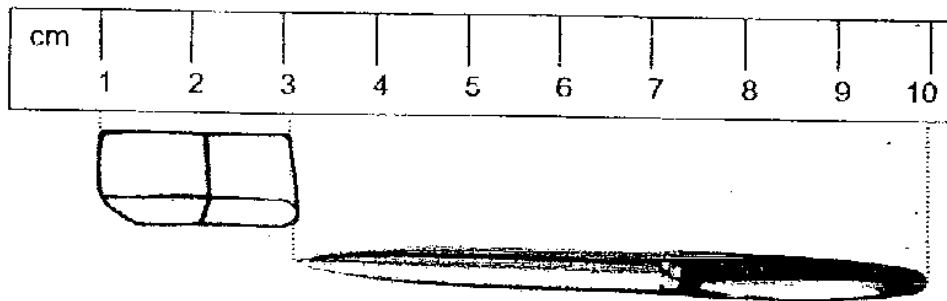

- (1) 5
- (2) 2
- (3) 3
- (4) 7

()

15. What is the mass of the 3 balls?

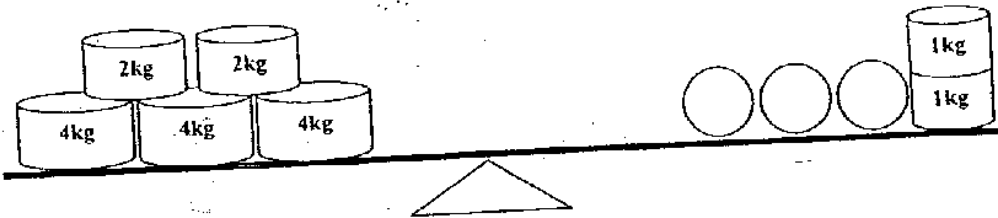

- (1) 10 kg
- (2) 12 kg
- (3) 14 kg
- (4) 16 kg

16. $241 + 129 =$ _____ tens

- (1) 37
- (2) 30
- (3) 3
- (4) 7

17. A piece of wire is bent to form a rectangle as shown.
What is the length of the wire used?

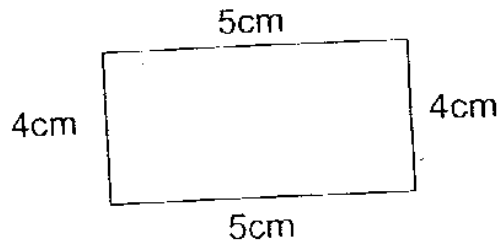

- (1) 8 cm
- (2) 9 cm
- (3) 10 cm
- (4) 18 cm

18. What is the mass of the mango?

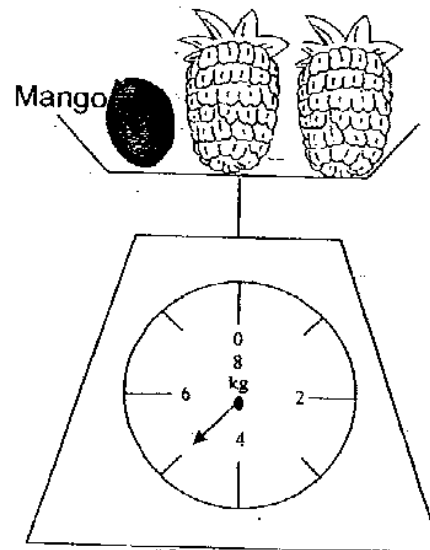
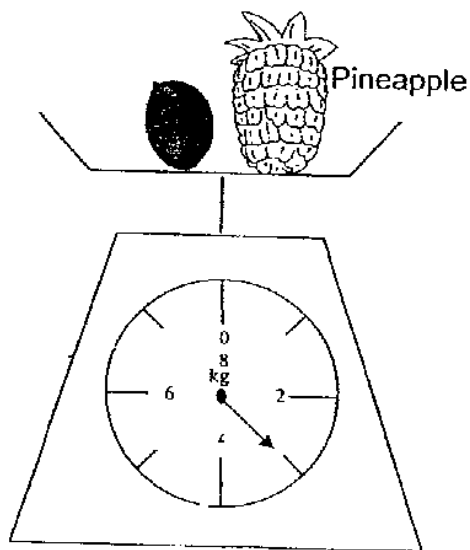

- (1) 1 kg
- (2) 2 kg
- (3) 3 kg
- (4) 5 kg

()

19. John had 20 cookies. He ate 4 cookies and put the rest into 2 tins. How many cookies were there in each tin?

- (1) 8
- (2) 10
- (3) 16
- (4) 26

()

20.

$$\triangle = 2$$

$$\triangle + \triangle = \square$$

$$\square = \underline{\hspace{2cm}}$$

What is the missing number?

- (1) 1
- (2) 2
- (3) 3
- (4) 4

()

Section B: (20 x 2m = 40m)

For each question, write the correct answer in the box provided. Give your answers in the units stated.

21. Fill in the box with the correct number.

Four hundred and nineteen	
---------------------------	--

22. Complete the number pattern.

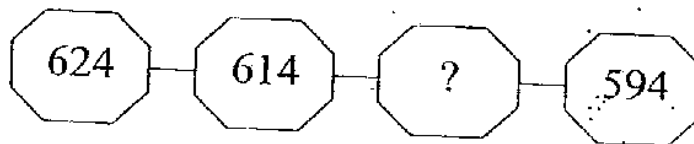

--

23. Arrange the numbers in order. Begin with the greatest number.

665	698	999	979
-----	-----	-----	-----

(greatest)

24. The mass of a box is 10 g. Find the mass of 4 similar boxes.

25. $21 \div 3 =$ _____

26. A stool has 4 legs. 3 such stools have _____ legs.

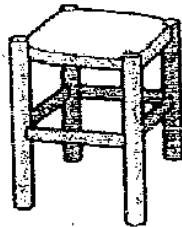

27. Which line is the longest?

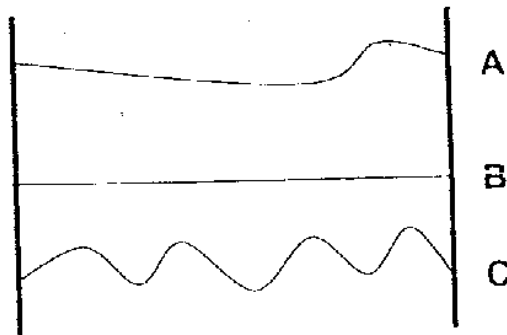

Line:

Study the diagram carefully and answer questions 28 to 30.

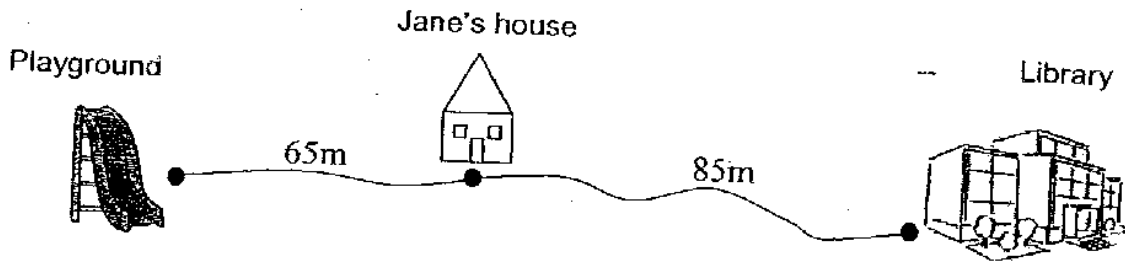

28. Jane's house is _____ m from the playground.

29. Jane left her house to cycle to the library. She has cycled 70m.
How much further did she have to cycle?

 m

30. Jane cycled from the library to the playground. How far did she cycle altogether?

 m

31. $435 - 3 \text{ tens} = \underline{\hspace{2cm}}$

32. $426 - \underline{\hspace{2cm}} = 79$

33. Gina is 115 cm tall. How tall is Stan?

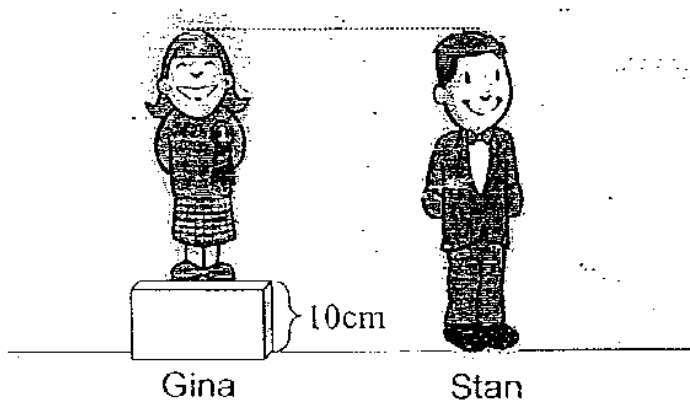
 cm

34. Ali is 40 kg.
He is 7 kg lighter than Devi.
How heavy is Devi?

35. Circle the candy sticks to show 5 equal groups.

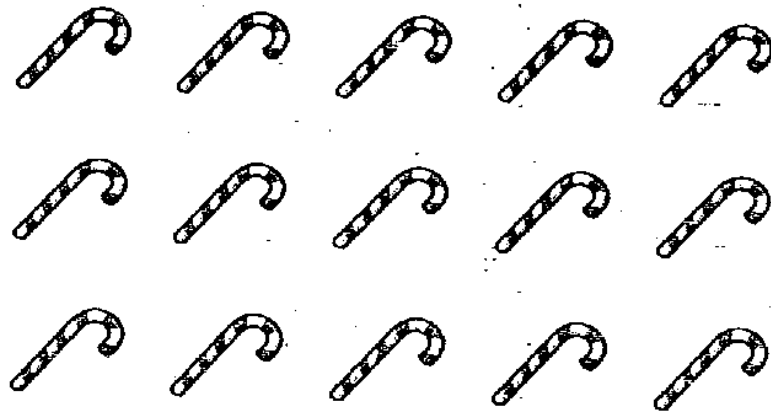



36. $5 \times \underline{\hspace{2cm}} = 10$

37. 431 children took part in a drawing contest. If 177 of them were boys, how many girls were there?

38. A baker sold 104 fewer muffins on Monday than on Tuesday. He sold 301 muffins on Monday. How many muffins did he sell on Tuesday?

39. I am thinking of a number. When I multiply it by 2, the answer is 18. What is the number?

40.  +  = 12

 = _____

Section C (5 x 4m = 20m)

Work out these problem sums carefully. For each sum, show your workings and statements clearly.

41. Sabrina has a piece of ribbon 260 cm long. She cuts away 88 cm. What is the length of the remaining piece of ribbon?

42. Anne used 370 g of flour to make curry puffs and 465 g of flour to bake a cake. She then had 128 g of flour left. How much flour did she have at first?

43. At a soccer match, Team A had 350 supporters. Team B had 80 fewer supporters than Team A. How many supporters were there in Team B?

44. 10 groups of children went camping. There were 3 boys and 2 girls in each group. How many children went camping?

45. Mrs Tan gives 30 stamps to her pupils.
Each pupil receives 3 stamps.
How many pupils are there?

End of Paper

ANSWER SHEET

NAN CHIAU PRIMARY SCHOOL - PRIMARY 2 MATHEMATICS 2007
SEMESTRAL ASSESSMENT (1)

1. 2
2. 2
3. 4
4. 3
5. 3
6. 4
7. 4
8. 4
9. 3
10. 3
11. 1
12. 2
13. 1
14. 1
15. 3
16. 1
17. 4
18. 1
19. 1
20. 4
21. 419
22. 604
23. 999, 979, 698, 665
24. 40g
25. 7
26. 12 legs
27. C
28. 65m
29. 15m
30. 150m

31) 405

32) 347

33) 125m

34) 47kg

35)

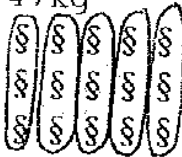

36) 2

37) 254

38) 405

39) 9

40) 6

41) $260 - 88 = 172$

Sabrina had left 172cm to that long ribbon.

42) $370 + 405 + 128 = 963$

Anne had 963g at first

43) $350 - 80 = 270$

Team B has 270 supporters

44) $10 \times 5 = 50$

50 children went camping.

45) $30 \div 3 = 10$

Mrs Tan have 10 pupils.