

NANYANG PRIMARY SCHOOL  
SECOND SEMESTRAL EXAMINATION  
2007

PRIMARY 1  
MATHEMATICS

DURATION: 1 HOUR 30 MINUTES

Section A	/ 40
Section B	/ 40
Section C	/ 20

Total:	/ 100
--------	-------

Name: \_\_\_\_\_ ( )

Class: Primary 1 ( )

Date: 31 October 2007

Parent's Signature: \_\_\_\_\_

DO NOT OPEN THIS BOOKLET UNTIL YOU ARE TOLD TO DO SO.

FOLLOW ALL INSTRUCTIONS CAREFULLY.

ANSWER ALL QUESTIONS.

**Section A**

Questions 1 to 20 carry 2 marks each.

For each question, four options are given.

One of them is the correct answer.

Choose the correct answer and write its number (1, 2, 3 or 4) in the brackets ( ) provided. (Total: 40 marks)

1. What is the missing number in the number bond below?

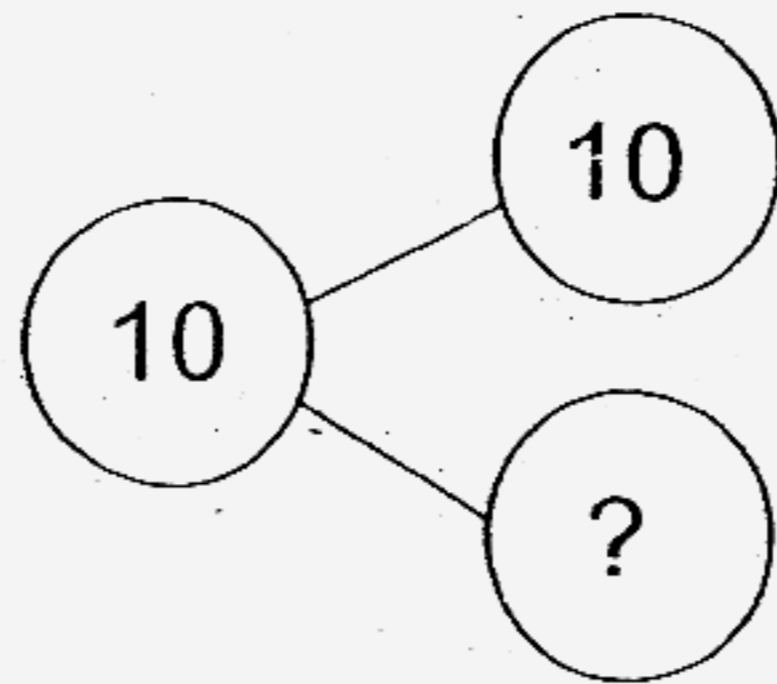

~~(1) 0~~

~~(2) 10~~

~~(3) 20~~

~~(4) 100~~

( )

2. Which one of the following pictures shows  $2 + 4 = 6$ ?

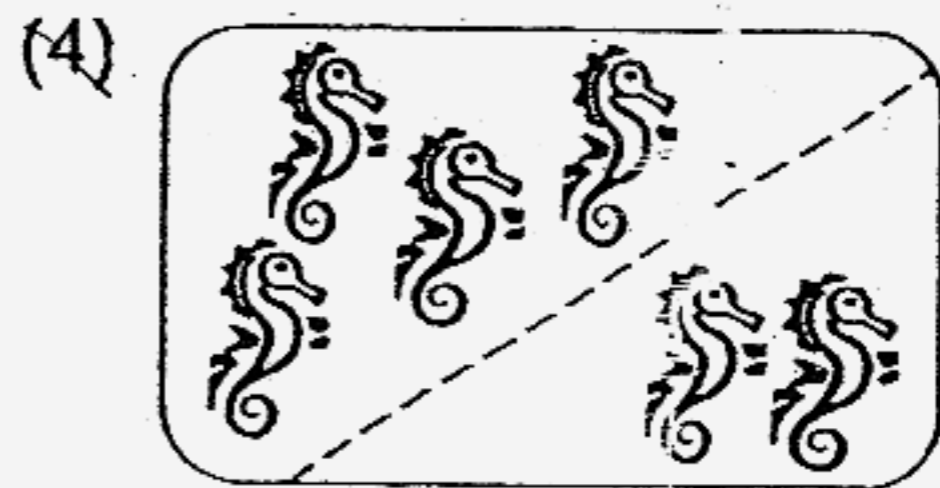
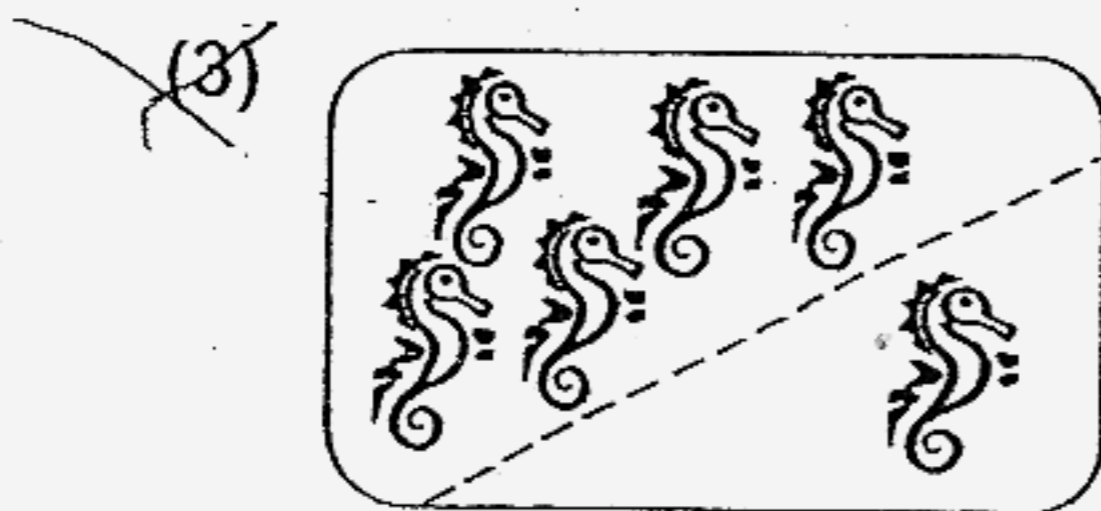
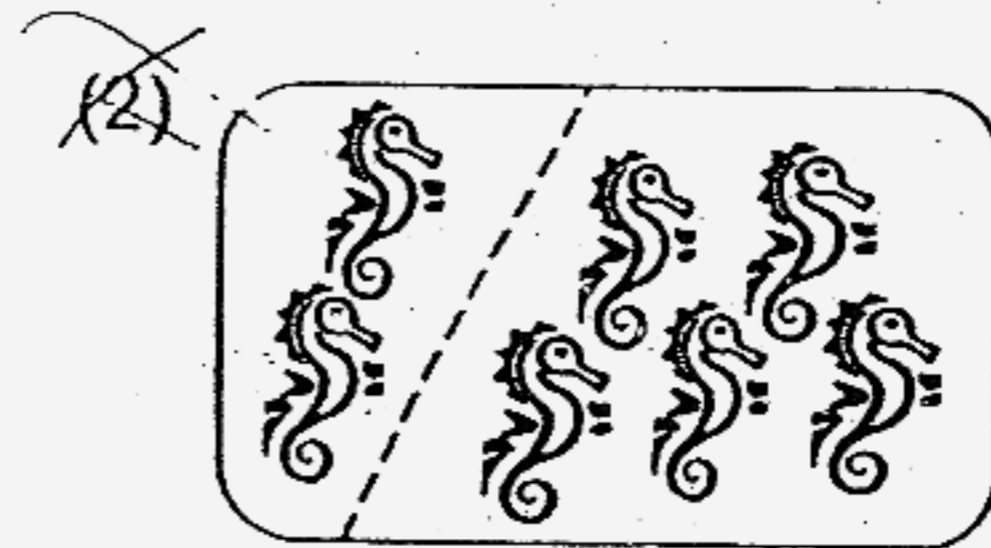
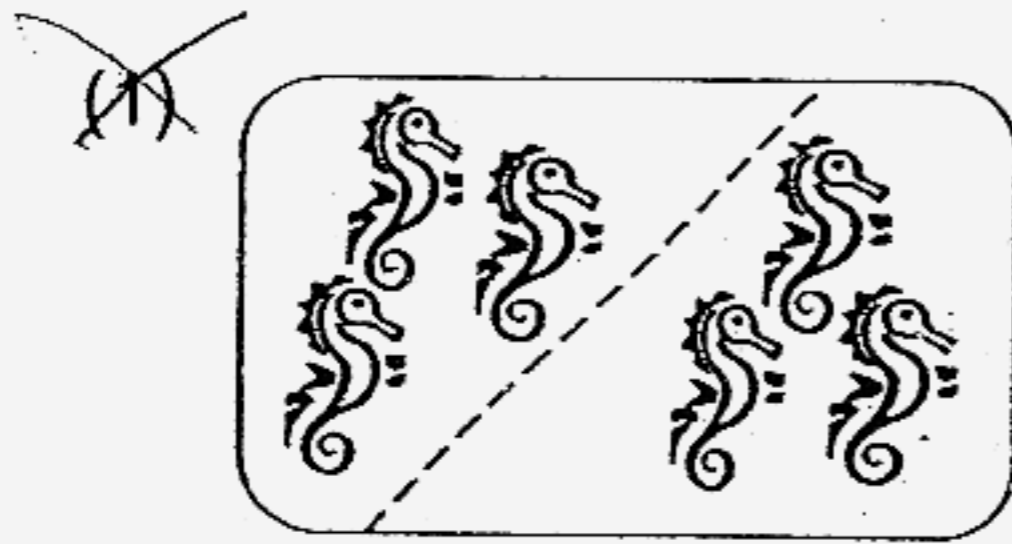

( )

3. What is the missing number in the box?

$$8 + 5 + 9 = \boxed{?}$$

~~(1)~~ 13

~~(2)~~ 14

~~(3)~~ 21

~~(4)~~ 22

( )

4. Study the figure and table carefully. What is the missing number in the box?

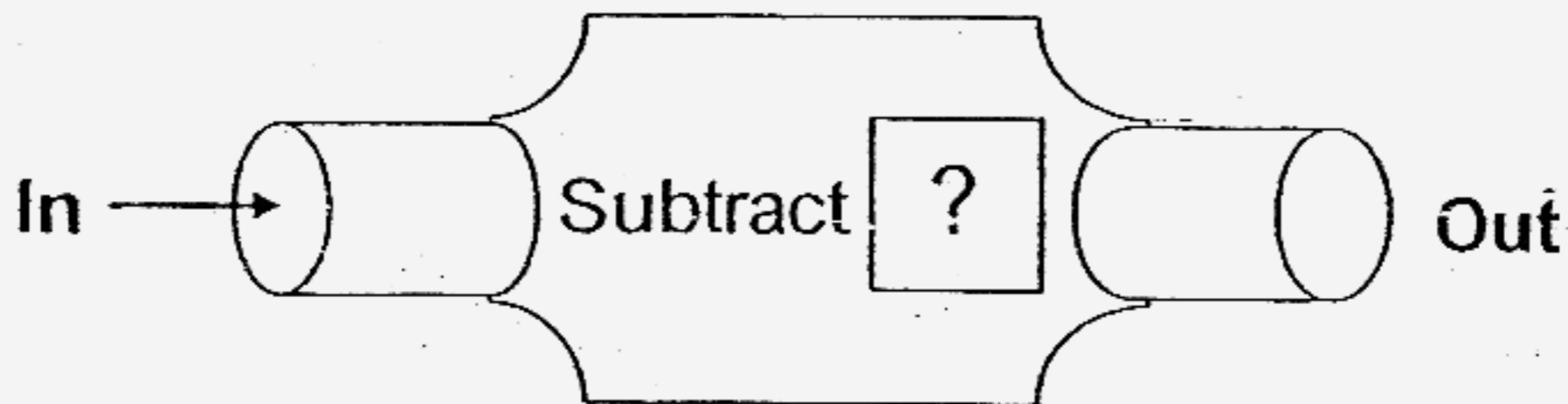

In	7	4	10
Out	5	2	8

~~(1)~~ 6

~~(2)~~ 2

~~(3)~~ 3

~~(4)~~ 18

( )

5. Uncle Edmund had 18 doughnuts. He gave 6 doughnuts to his friends. How many doughnuts had he left?

~~(1)~~ 12

~~(2)~~ 2

~~(3)~~ 13

~~(4)~~ 24

( )

6 The sum of the numbers in the rectangle and the circle is \_\_\_\_\_.

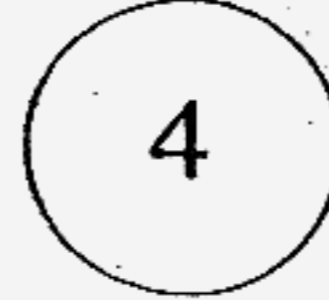
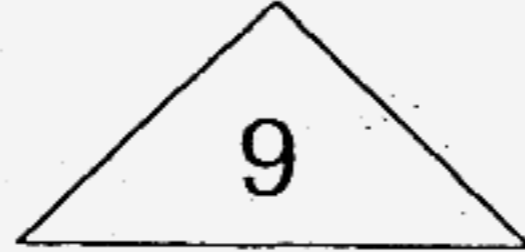
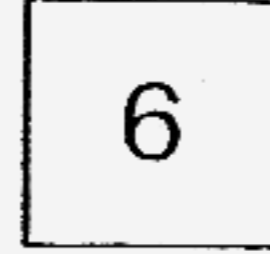
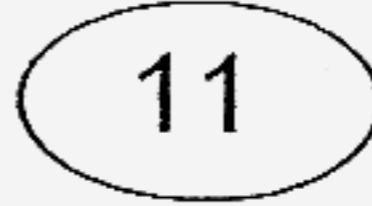
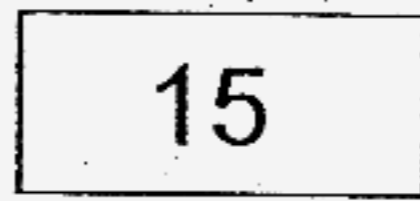

~~(1)~~ 10

~~(2)~~ 13

~~(3)~~ 19

~~(4)~~ 26

( )

7. Zora must give \_\_\_\_\_ toy truck to Paul so that they have the same number of toy trucks.

Zora's toy trucks

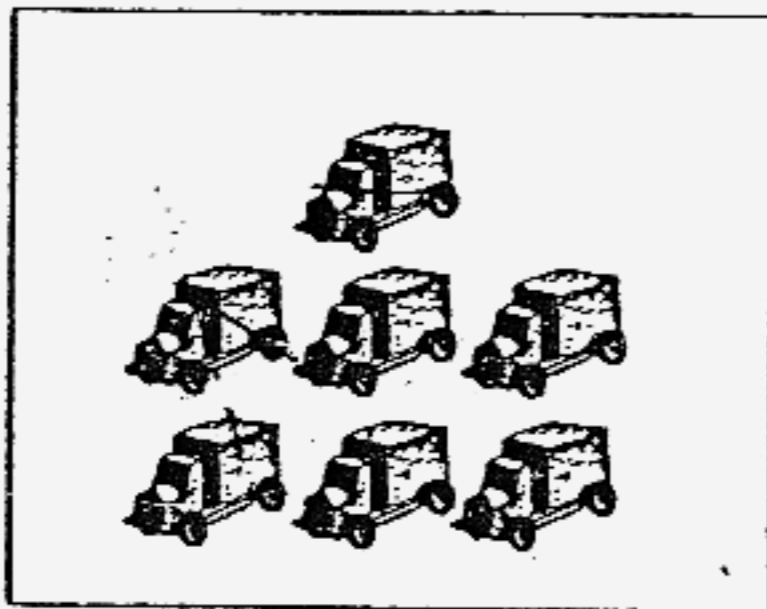

Paul's toy trucks

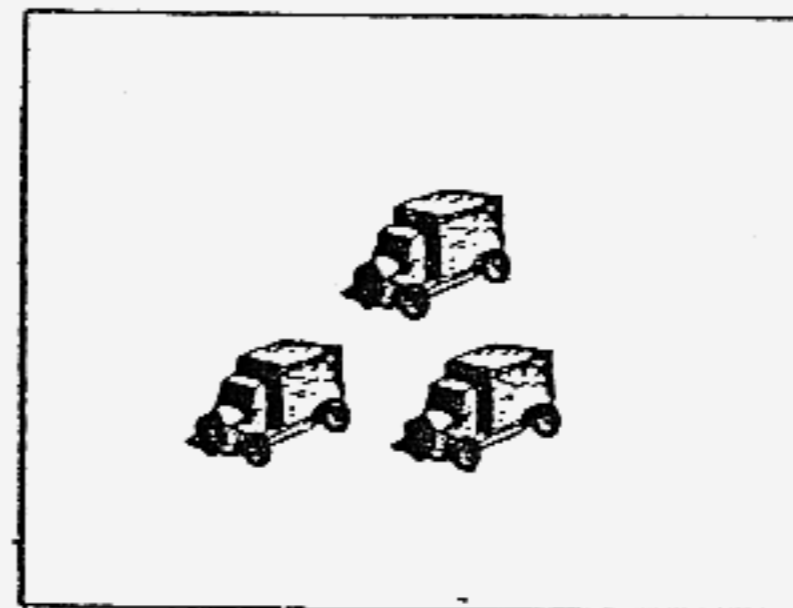

~~(1)~~ 10

~~(2)~~ 2

~~(3)~~ 5

~~(4)~~ 4

( )

8. Study the figure below. What does A stand for?

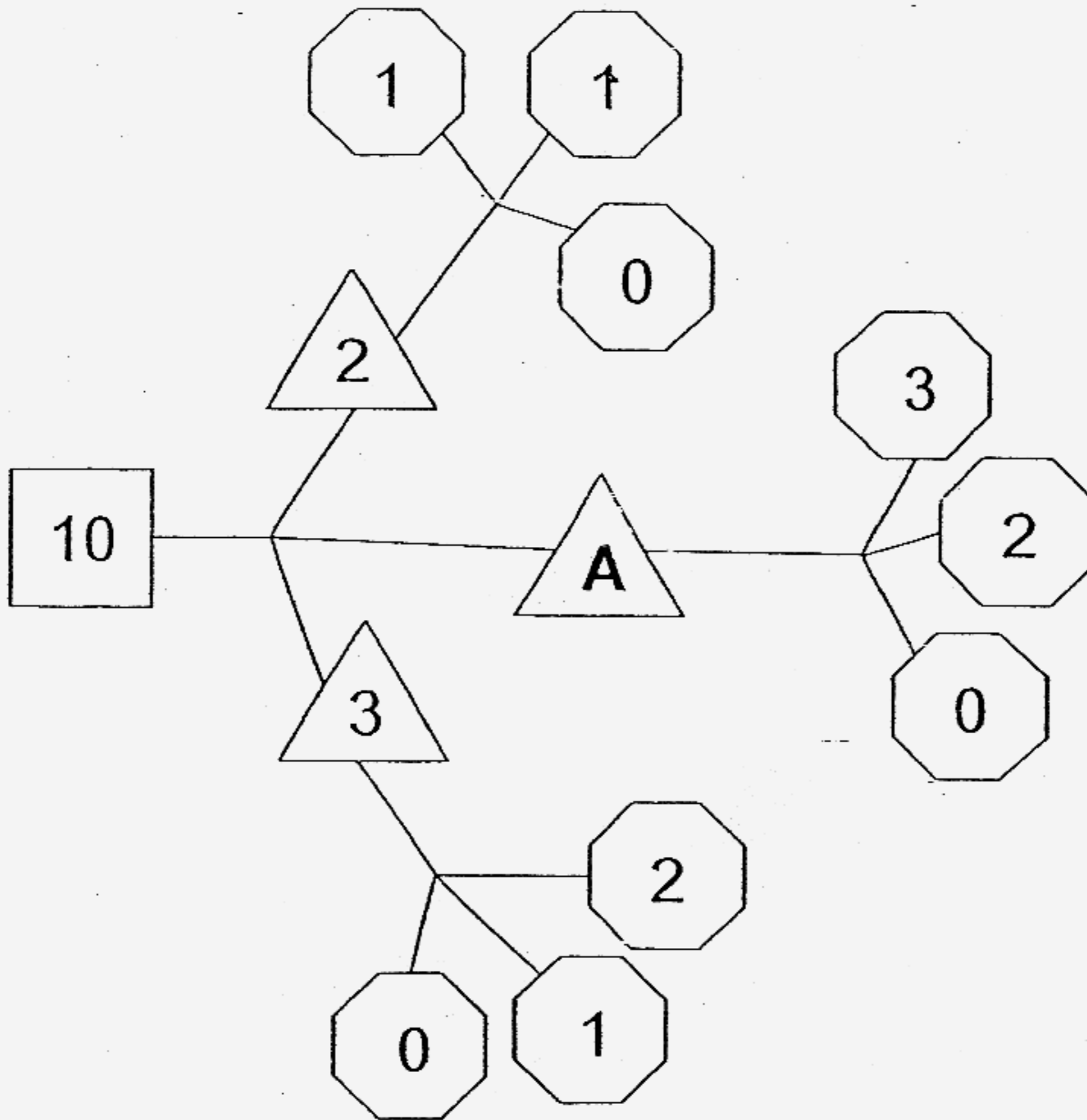

~~(1)~~ 1

~~(2)~~ 0

~~(3)~~ 5

~~(4)~~ 6

( )

9. The letter 'S' is \_\_\_\_\_ from the left.

RESPECT

~~(1)~~ 5th

~~(2)~~ 6th

~~(3)~~ 3rd

~~(4)~~ 4th

( )

10. Study the number pattern. Which number comes next?

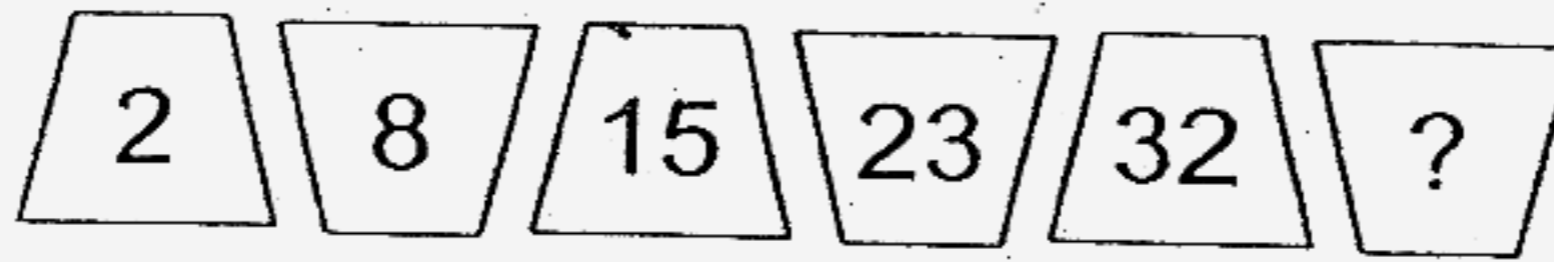

~~(1)~~ 38

~~(2)~~ 40

~~(3)~~ 41

~~(4)~~ 42

( )

11. Name the shape of the shaded face.

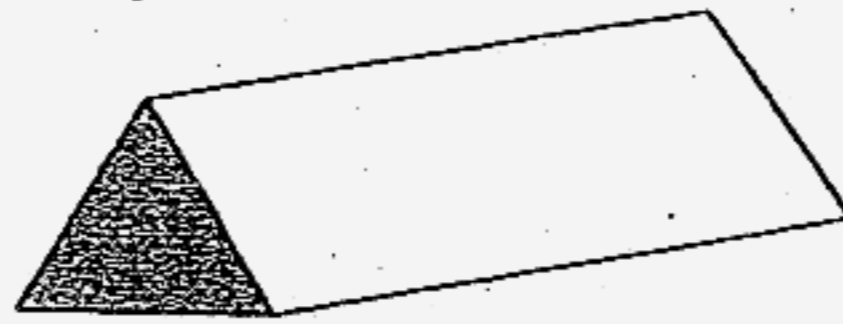

~~(1)~~ square

~~(2)~~ triangle

~~(3)~~ circle

~~(4)~~ rectangle

( )

12. What is the time shown on the clock below?

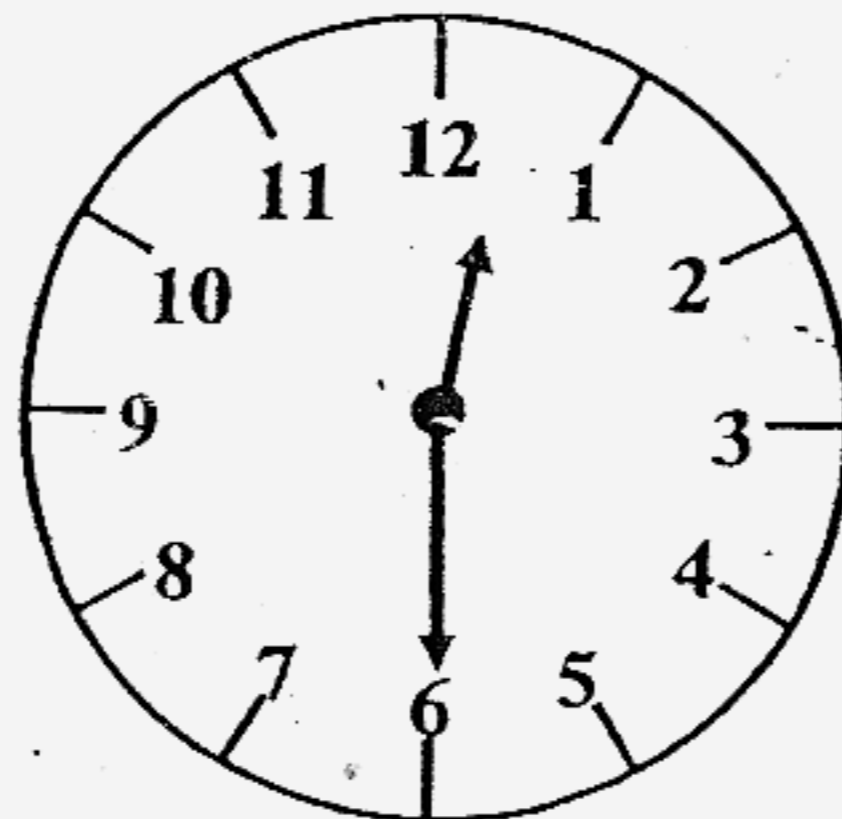

~~(1)~~ half past 1

~~(2)~~ half past 6

~~(3)~~ half past 3

~~(4)~~ half past 12

( )

13. Which 3 pieces will fit into the whole rectangle shown below?

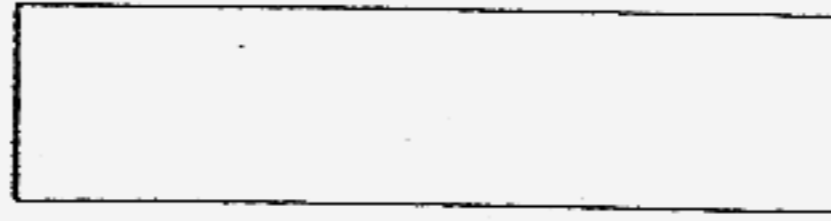

A



B

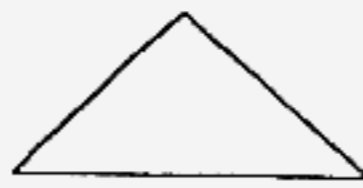

C



D

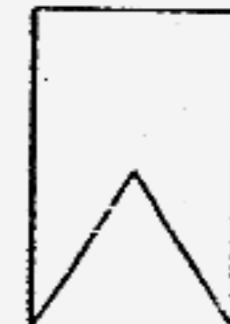

E

~~(1)~~ A, B and E

~~(2)~~ B, C and E

~~(3)~~ A, D and E

~~(4)~~ C, D and E ( )

14 The length of 3 crayons is about \_\_\_\_\_ keys long.

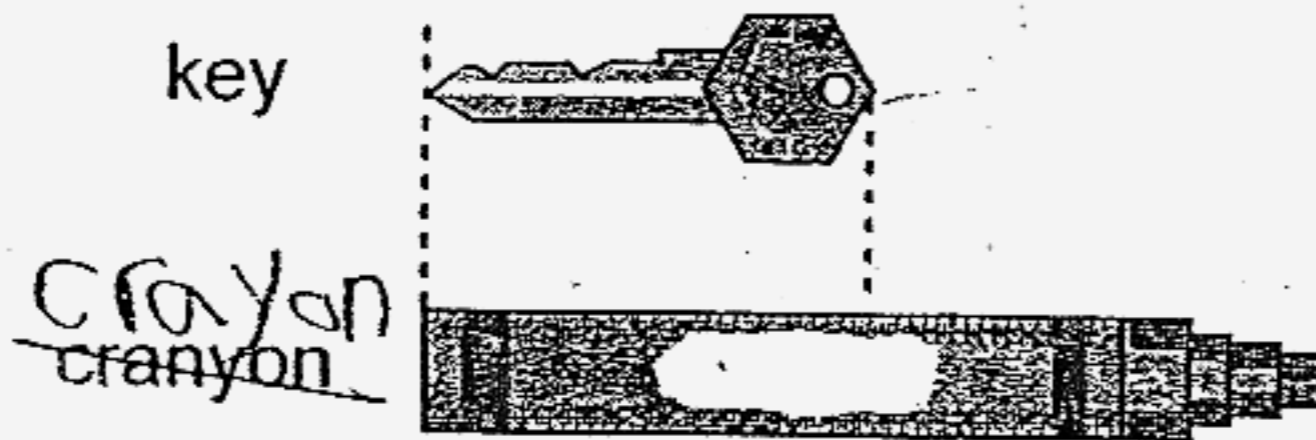

~~(1)~~ 5

~~(2)~~ 2

~~(3)~~ 3

~~(4)~~ 6 ( )

15. There are 5 balls in each box. How many balls are there in 3 such boxes?

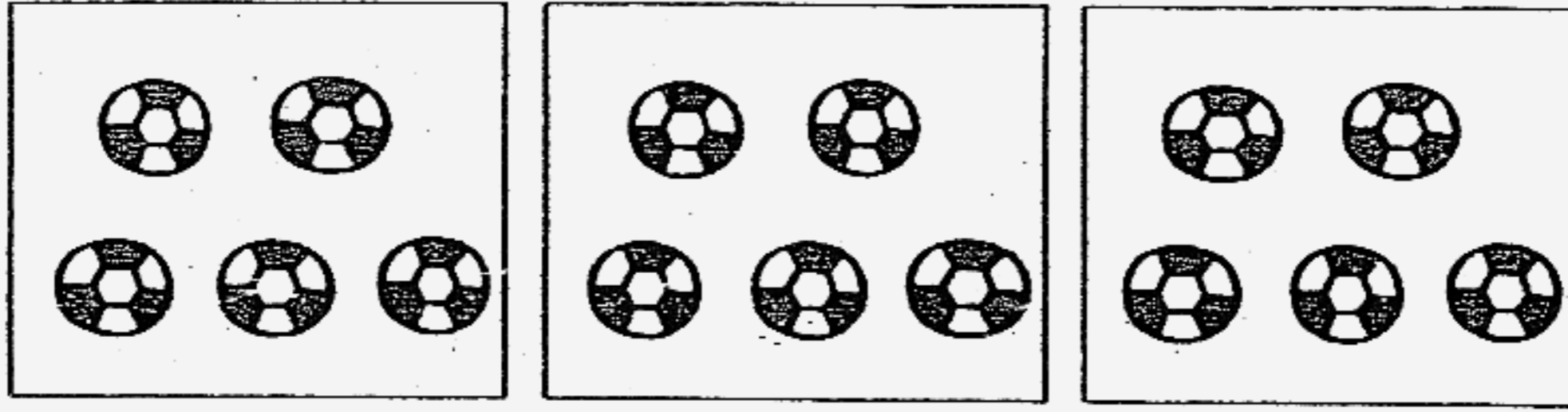

~~(1)~~ 8  
~~(3)~~ 14

~~(2)~~ 10  
~~(4)~~ 15

( )

16. Study the pictures below.



popcorn  
\$ 5



coke  
\$ 2

John bought a bag of popcorn and 2 cups of coke at the cinema. How much did he pay altogether?

~~(1)~~ \$ 7  
~~(3)~~ \$ 12

~~(2)~~ \$ 9  
~~(4)~~ \$ 14

( )

17. Study the figures and answer the question below.

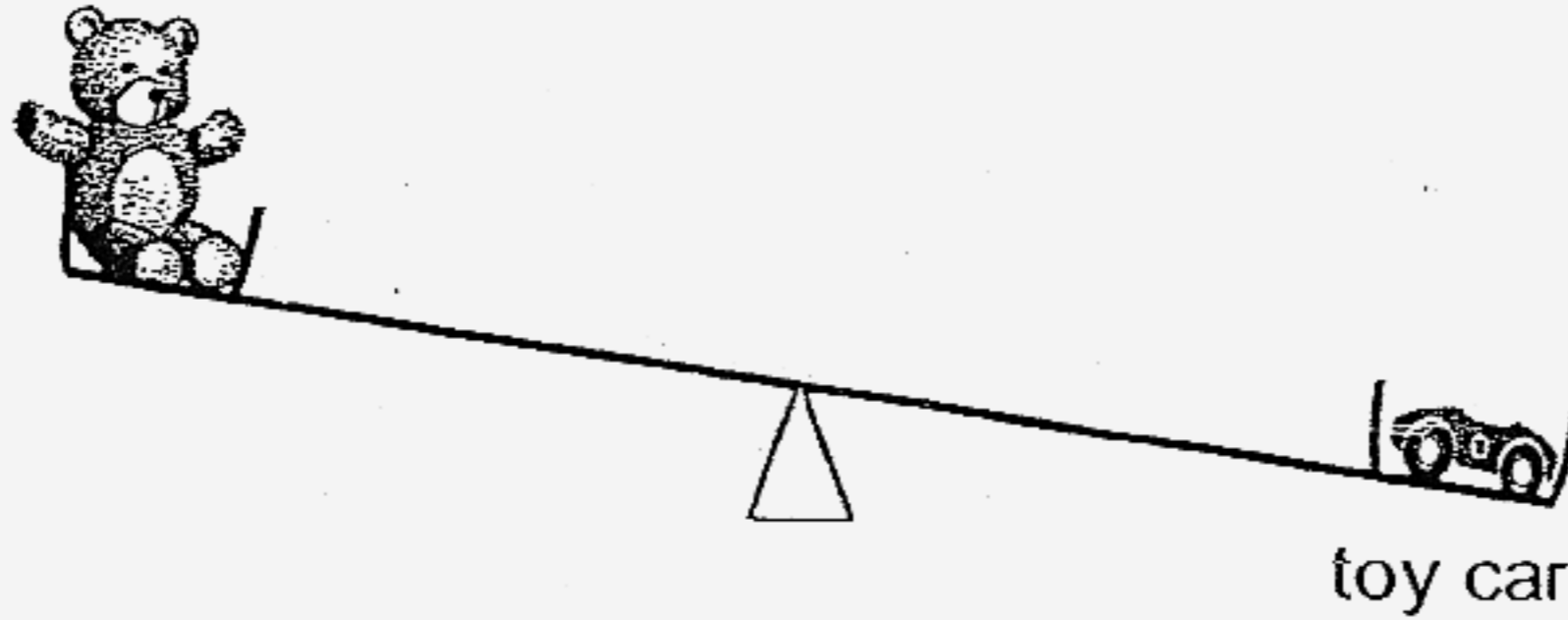
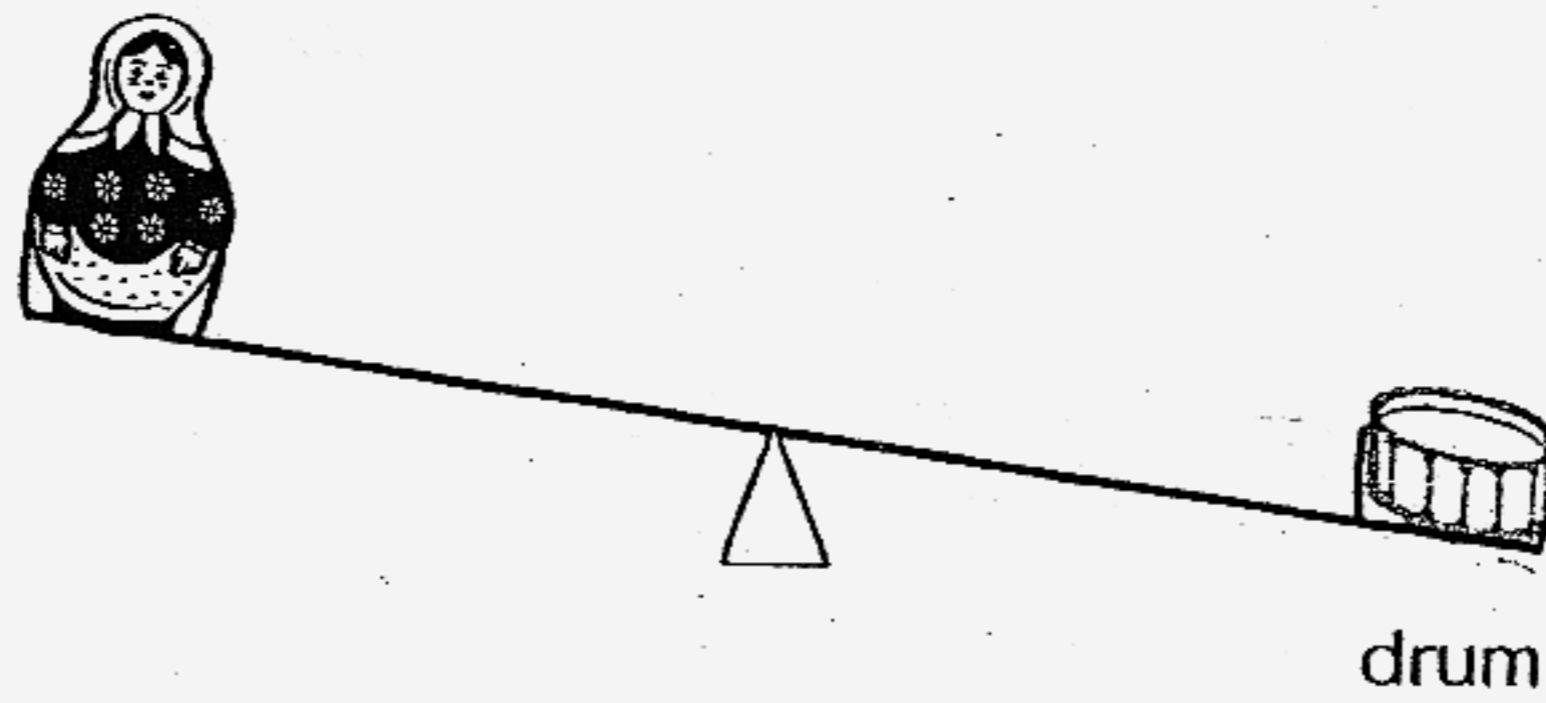
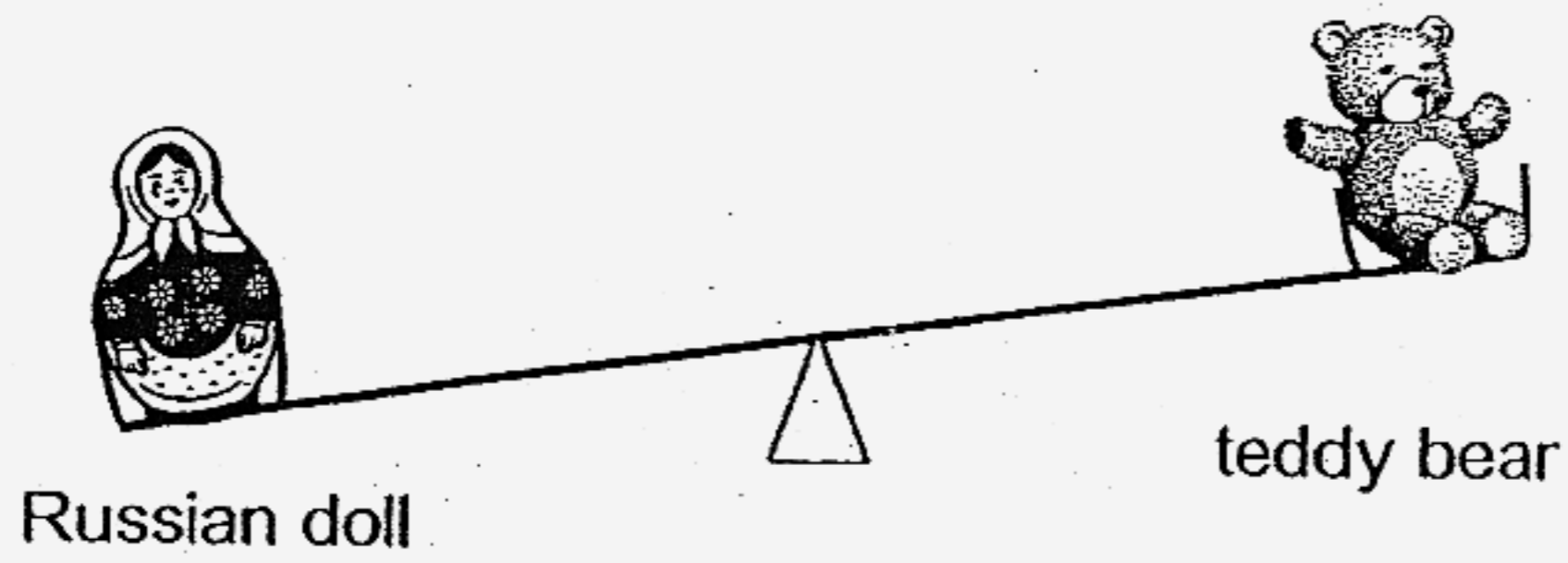

Which object is the lightest?

- ~~(1)~~ teddy bear
  - ~~(2)~~ drum
  - ~~(3)~~ Russian doll
  - ~~(4)~~ toy car
- ( )

18. Mrs Lim bought 15 pencils. She lost 1 pencil and gave the rest to her 2 daughters. How many pencils did each daughter get if they shared them equally?

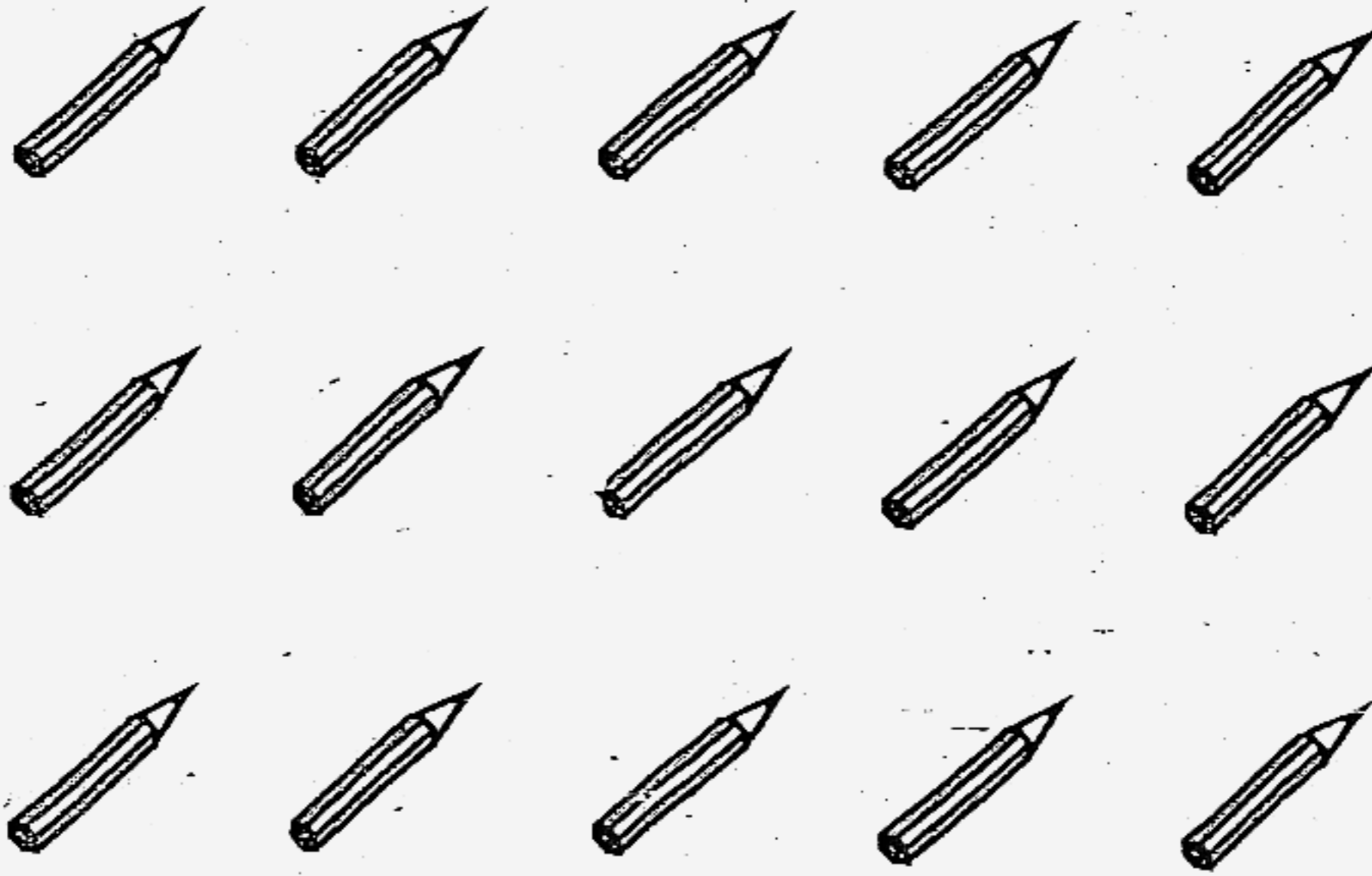

(1) 7

(2) 8

(3) 14

(4) 15

( )

19. The children have the following amounts of money. Who has the greatest amount of money?



Ali

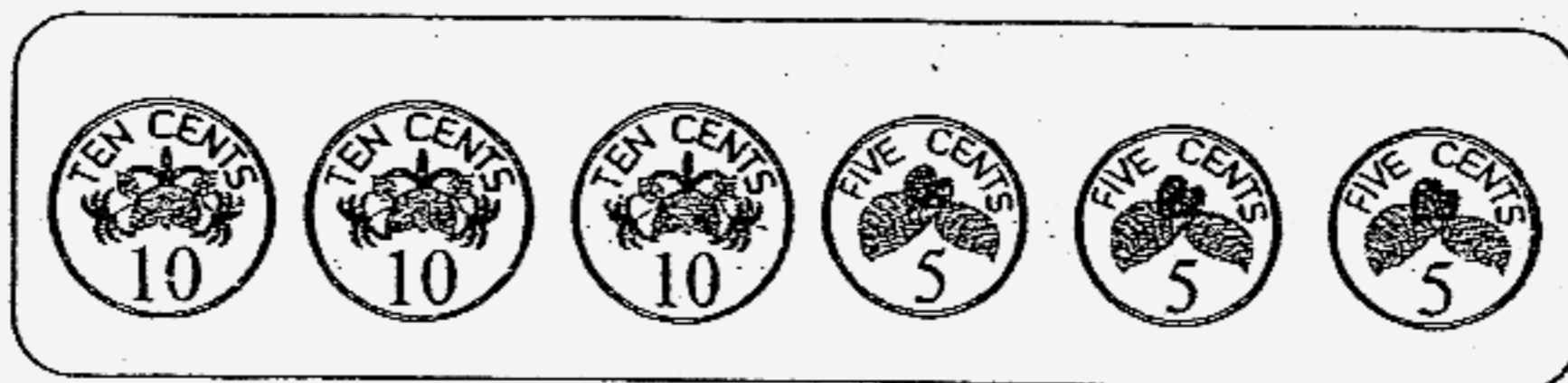

Billy

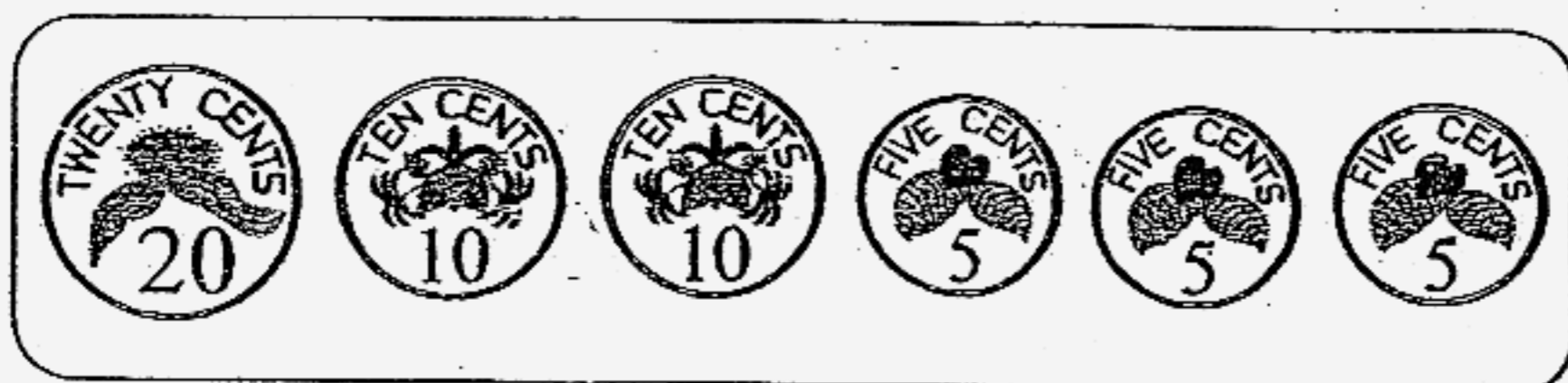

Cai Li

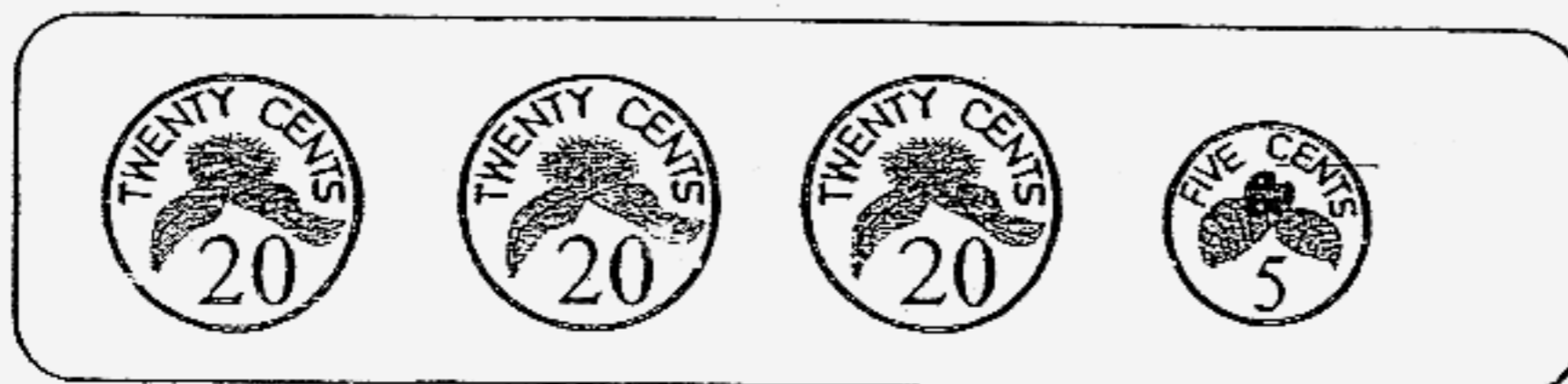

Dylan

~~(1)~~ Ali

~~(2)~~ Billy

~~(3)~~ Cai Li

~~(4)~~ Dylan

( )

20. The picture graph below shows how some children go to school.

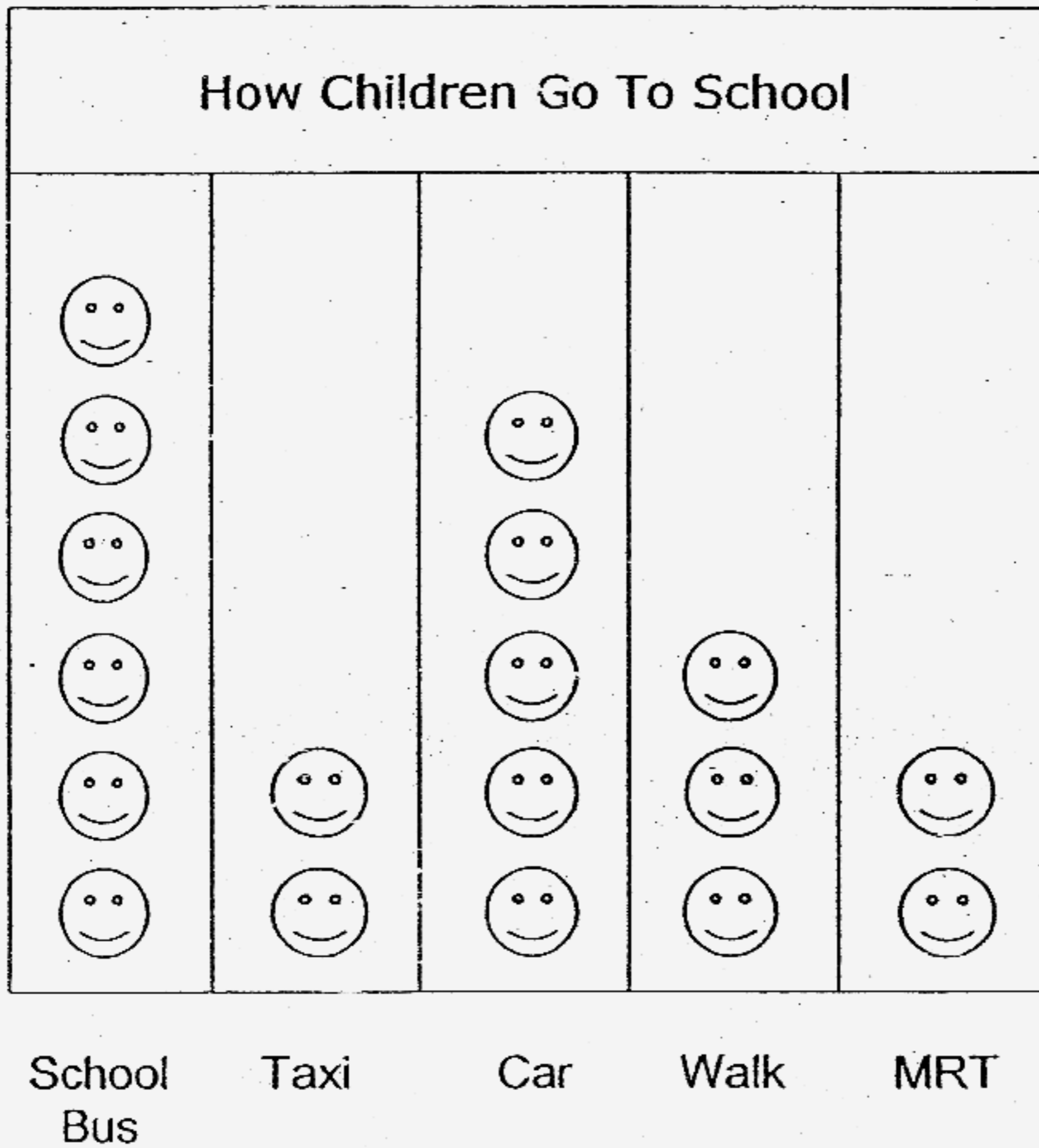

Each  stands for 1 child.

How many more children go to school by car than by MRT?

~~(A)~~ 5                      ~~(2)~~ 2  
~~(B)~~ 3                      ~~(4)~~ 7                      (     )

**Section B**

Questions 21 to 40 carry 2 marks each.

Write your answers in the spaces provided.

(Total: 40 marks)

21. What is the missing number in the box?

$$\boxed{?} \text{ tens} + 18 \text{ ones} = 68$$

22. Yani bought some oranges. She used 6 oranges to make orange juice and had 3 oranges left. How many oranges did she buy?

23. When 8 is added to a number, the answer is 25. What is the number?

24. Write '+' or '-' in the circles to complete the number sentence below.

$$9 \bigcirc 4 = 4 \bigcirc 1$$

25. Write the correct answers in the circles.

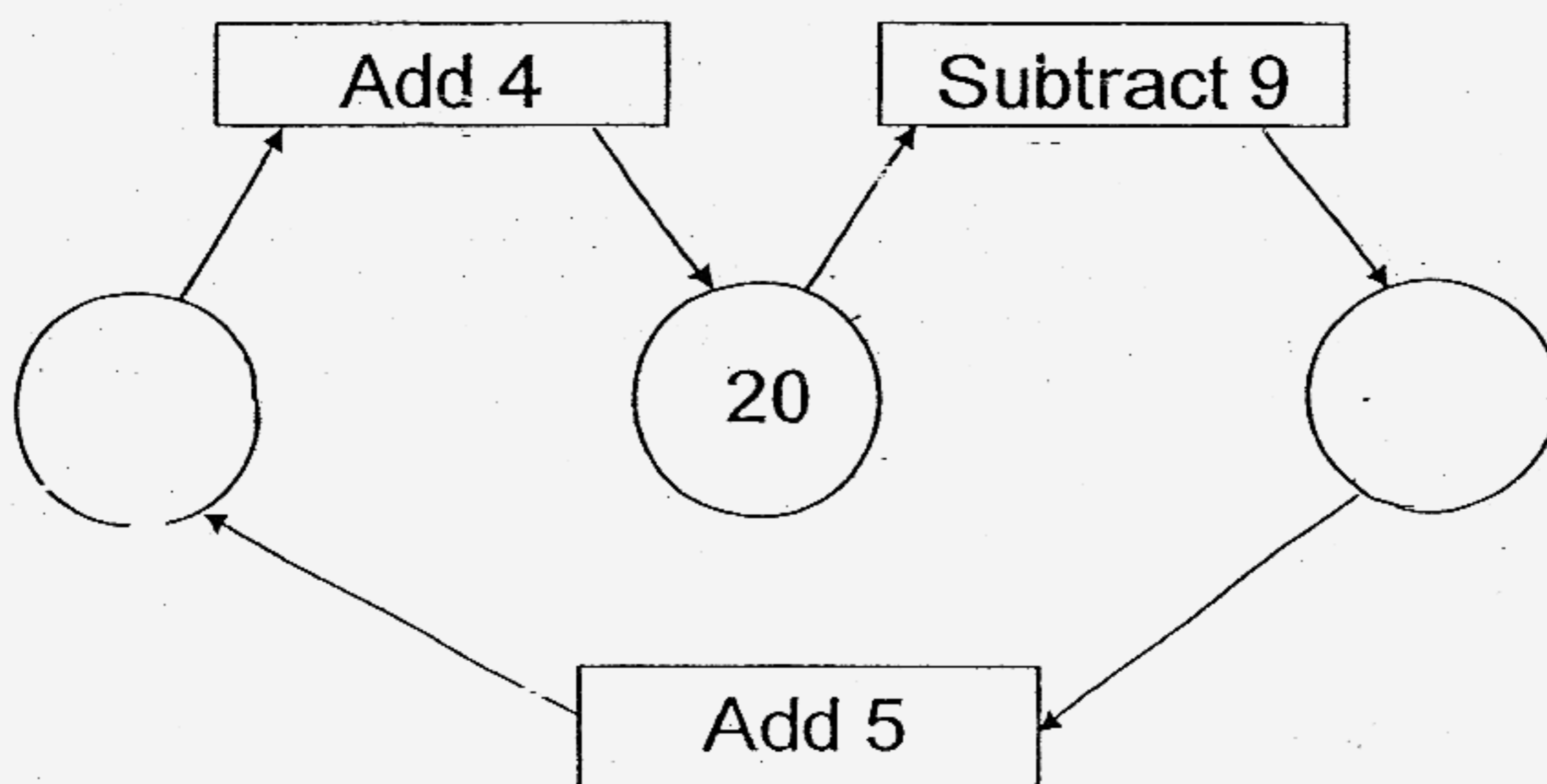

26. What is the missing digit in the box?

$$\begin{array}{r} \boxed{?} 5 \\ - 49 \\ \hline 36 \end{array}$$

27. The numbers on each side of the triangle add up to 98. What numbers should P and Q be?

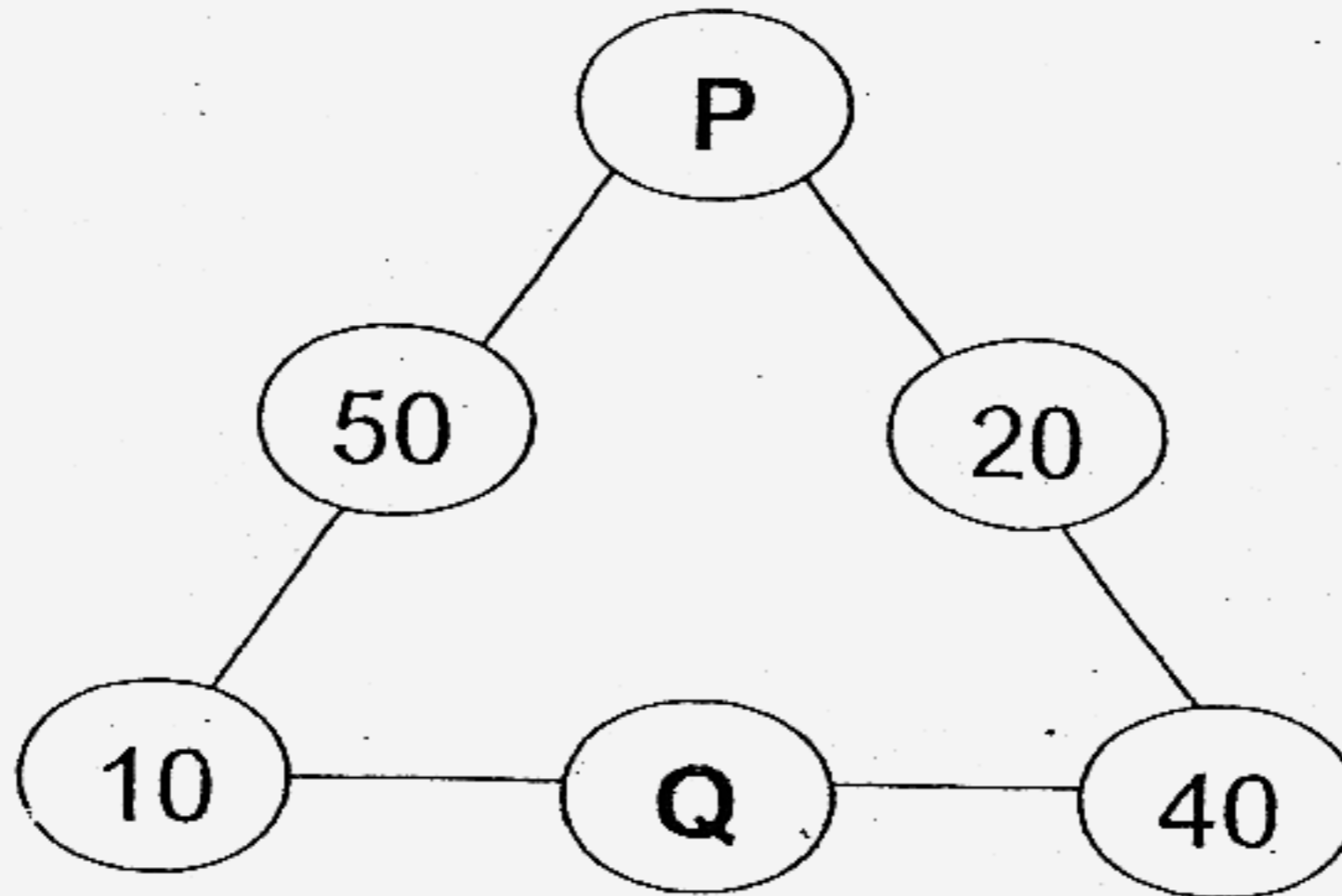

P =

Q =

28. Study the figure below.

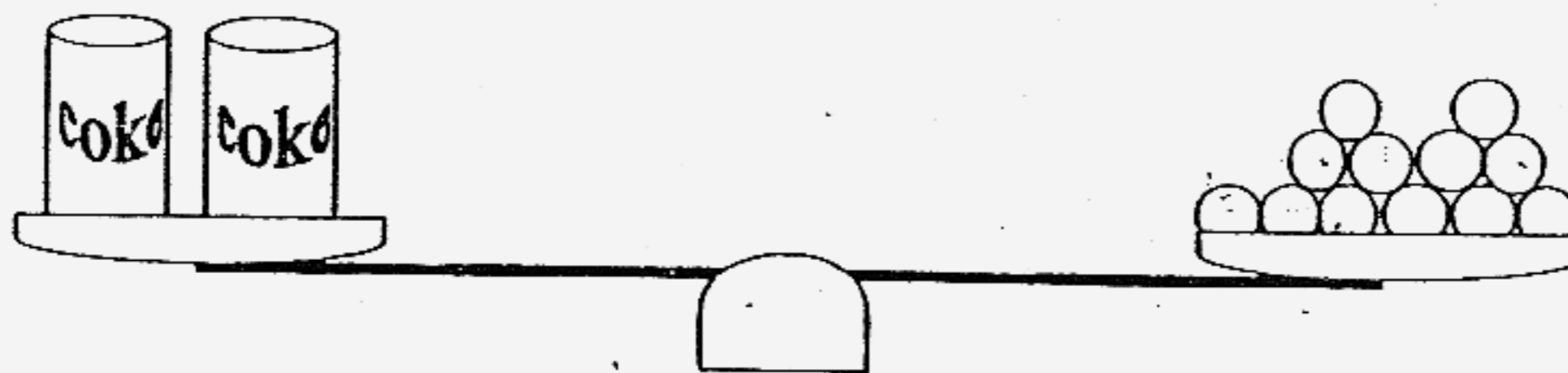

The mass of 1 can of coke is about  g.

29. Study the pictures below and fill the answers in the boxes.

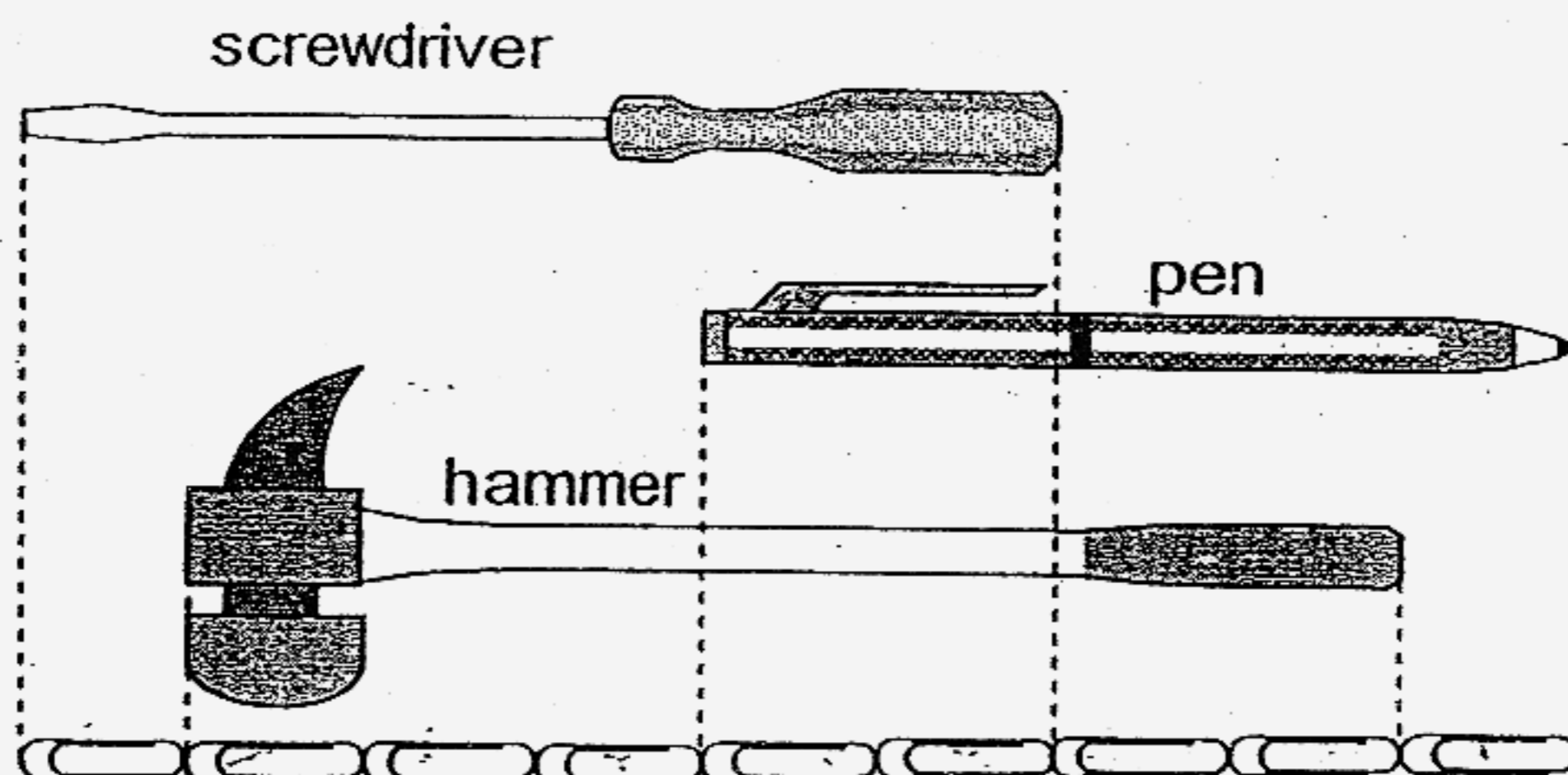

The screwdriver is longer than the  but shorter than the

30. Circle the heart shapes into 8 equal groups.

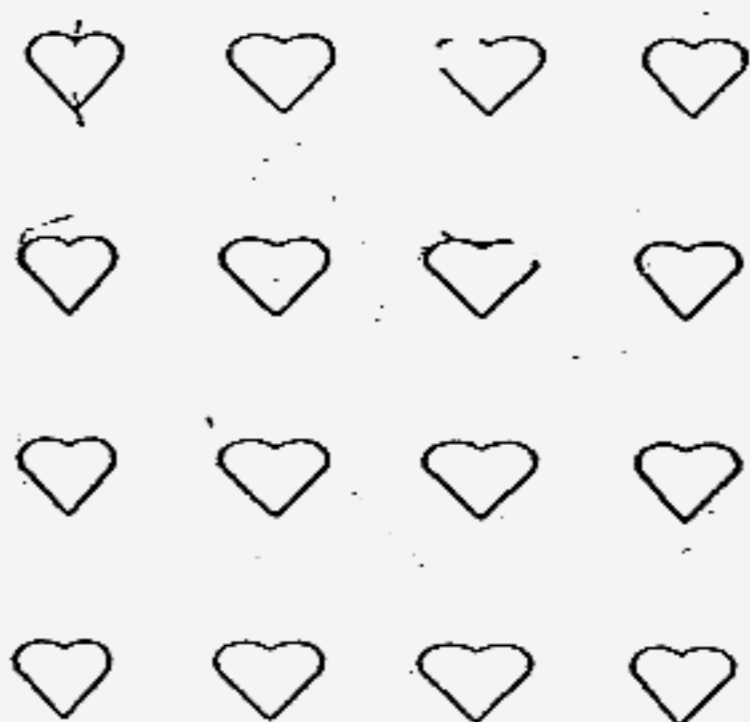

How many heart shapes are there in each group?

31. Study the pictures below and write a multiplication sentence.

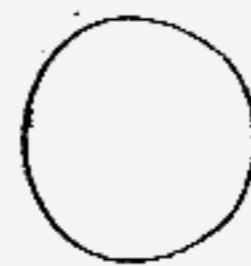
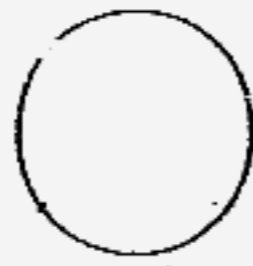
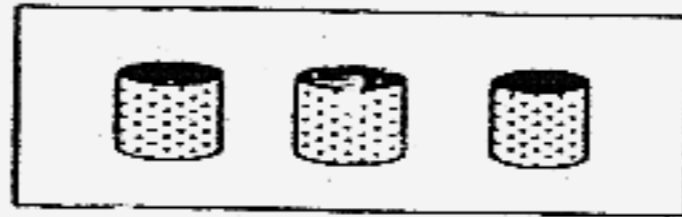
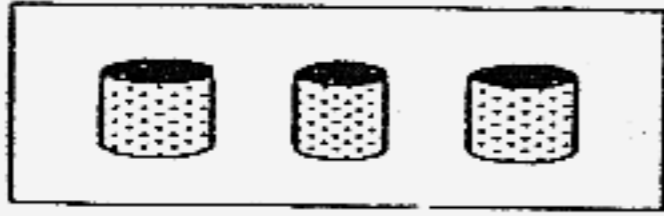
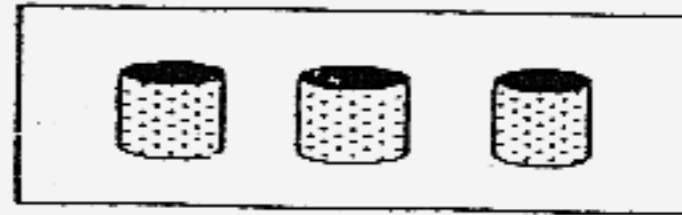
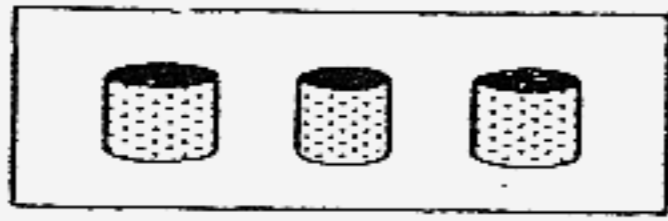

32. Celine has 20 candies.  
She wants to group them equally in packs of 5.  
How many packs of candies will she have?

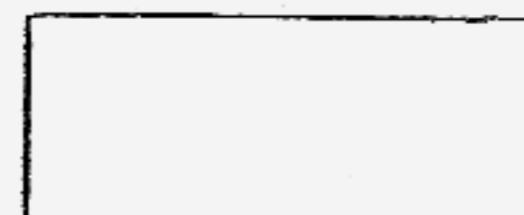
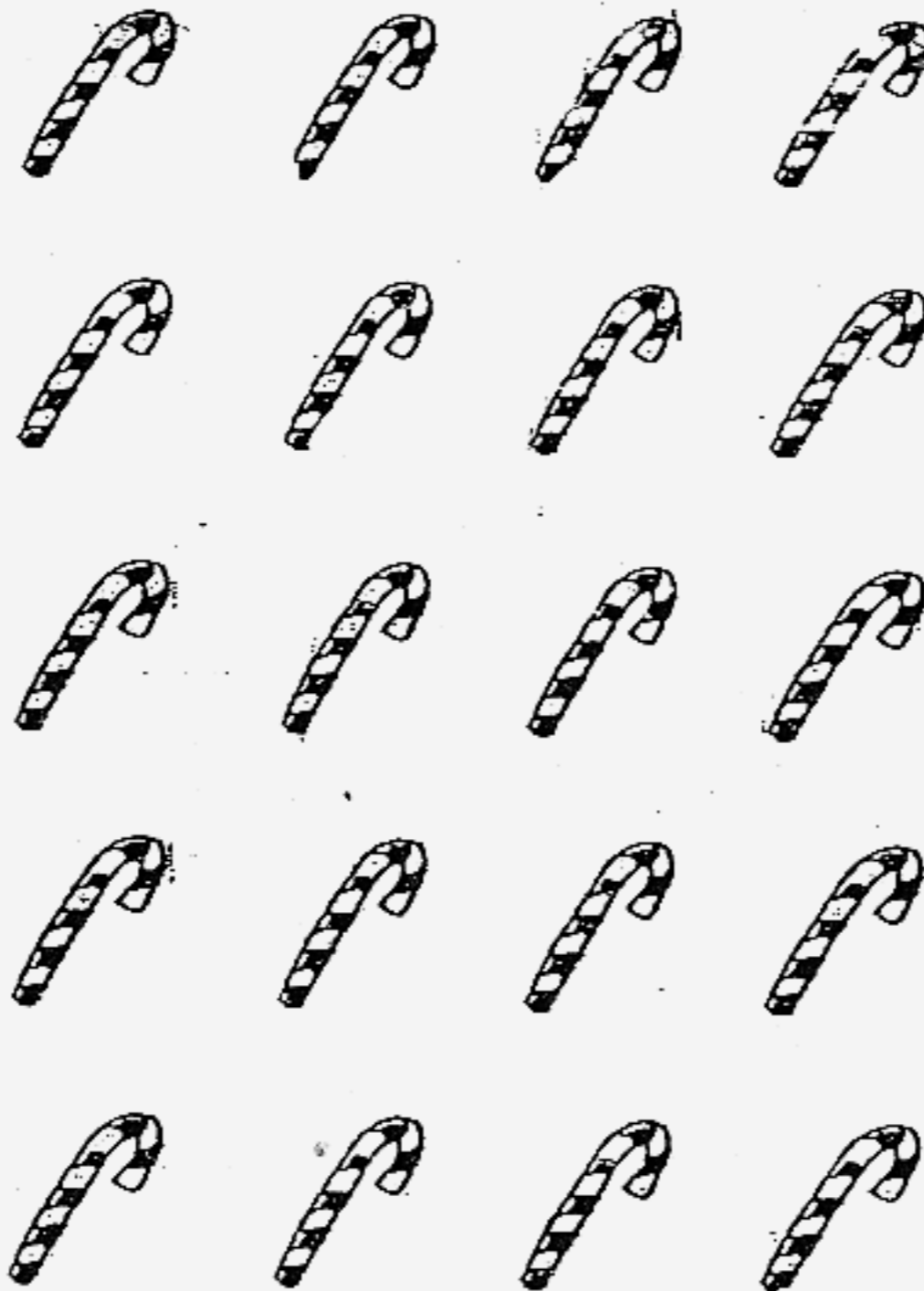

33. Study the figure below.

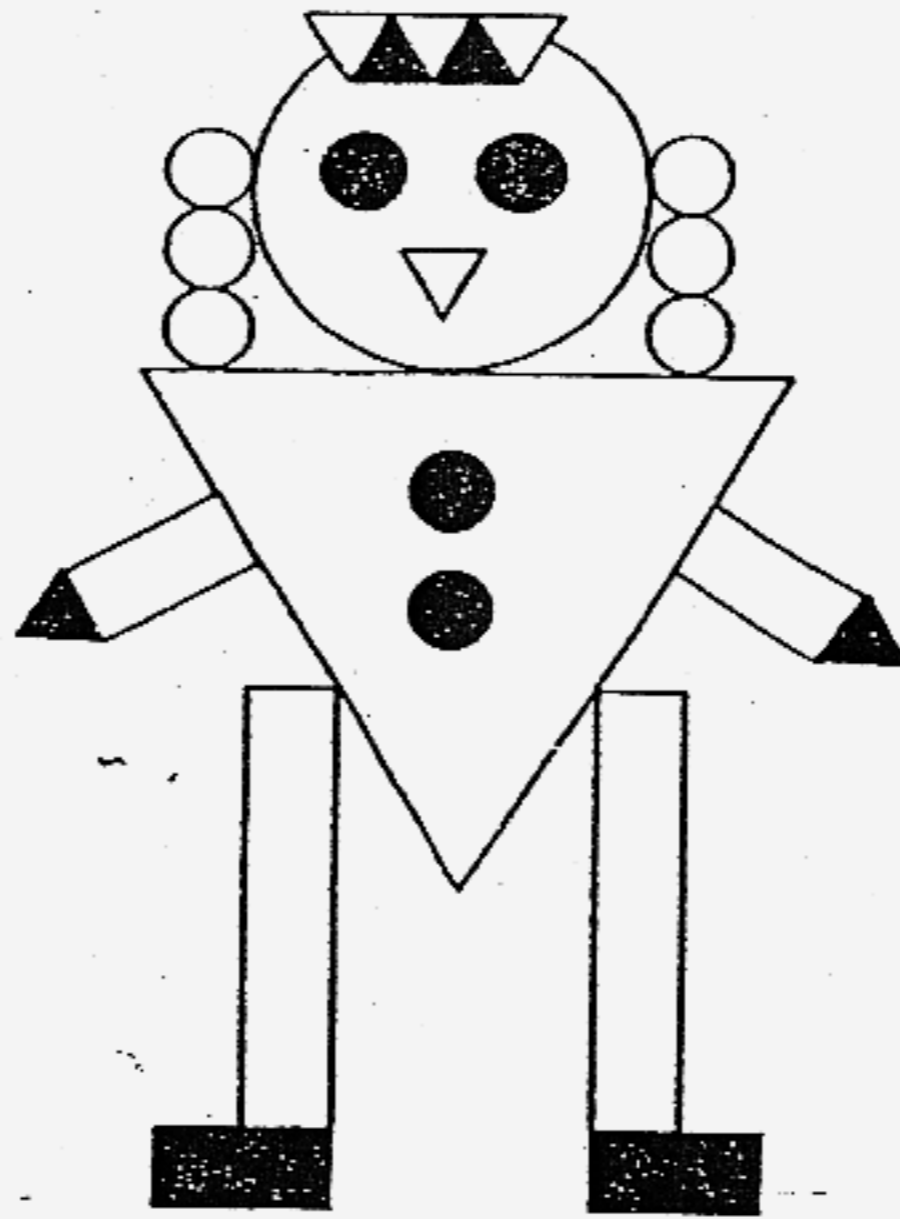

There are  small triangles.

There are  big rectangles.

34. Study the pattern below.

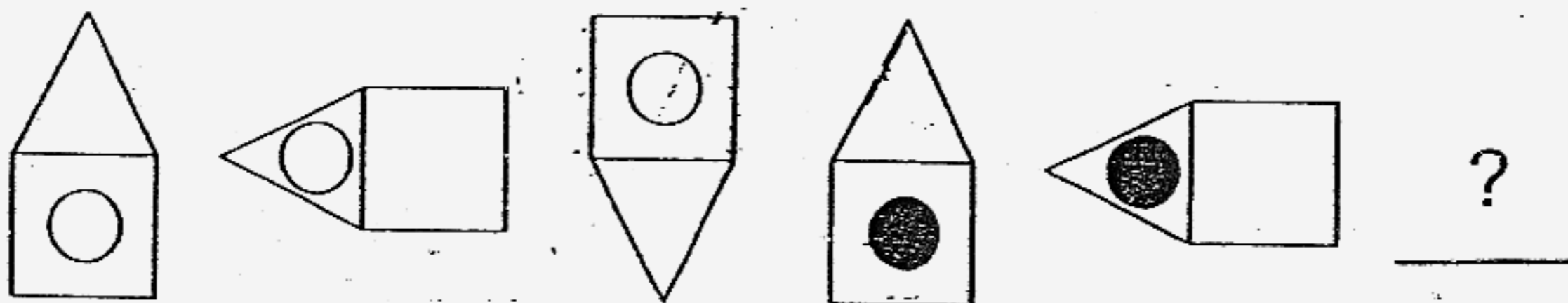

Circle the figure that comes next in the box below.

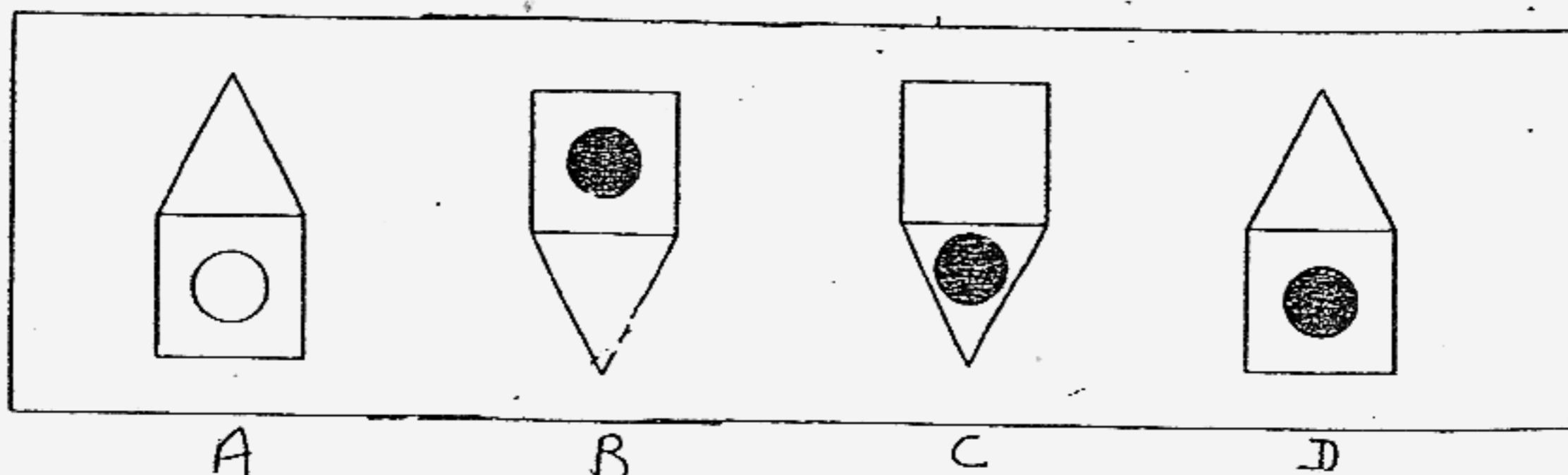

35. Kennedy started playing computer games at the time shown below. He played for half an hour.



Starting Time

Which clock below shows the time he finished playing?



Clock P

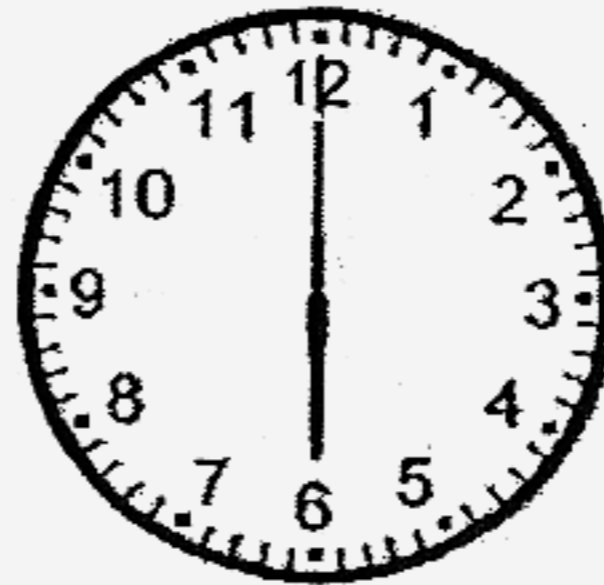

Clock Q



Clock R

Clock

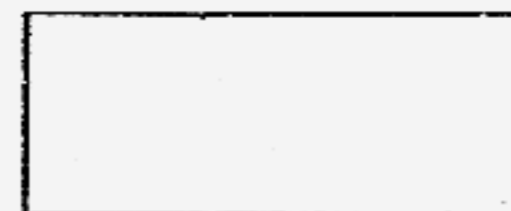

36. Sharlyn bought a lollipop for 65 cents. She gave the cashier 4 twenty-cent coins. How much change did she get back?

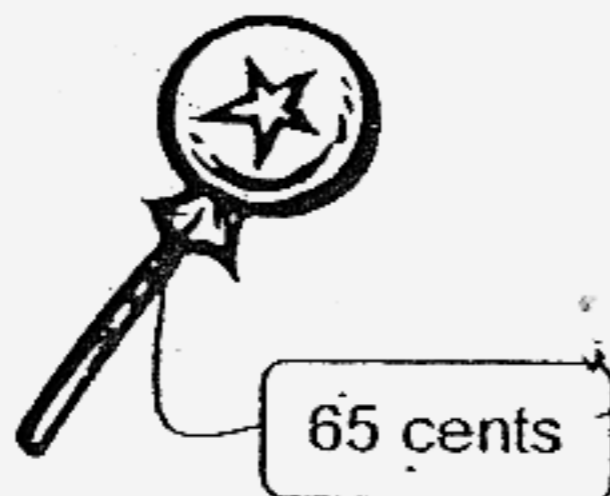

cents

37. Circle 5 notes to show \$21.

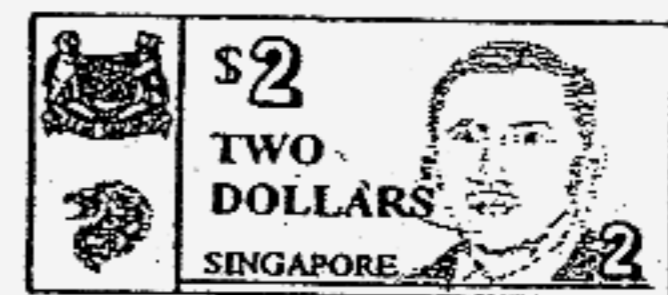
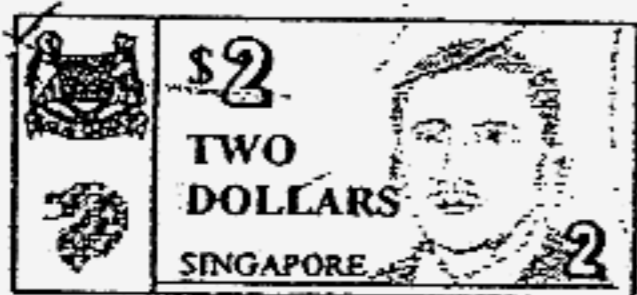

38. Vases A, B and C each contain some flowers.  
 Vase A has 2 fewer flowers than Vase B.  
 Vase A has 4 more flowers than Vase C.  
 Vase B has 13 flowers.  
 How many flowers are there in Vase C?

Vase A



Vase B



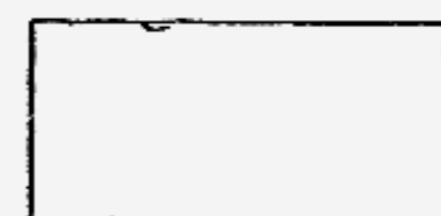

Vase C

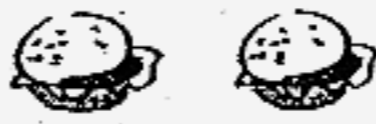

flowers

39. The picture graph below shows the burgers Mr Lee sold to a group of children.

Burgers sold	
Cheeseburger	
Fish Fillet	
Chicken burger	
Beef burger	?
Each  stands for 1 burger.	

If Mr Lee sold 23 burgers to the group of children, how many beef burgers did he sell?

40. KeXin, Lynn, Mala and Nan were queuing up in the canteen to buy food.  
Mala stood between KeXin and Lynn.  
Nan came after KeXin.  
Who was first in the queue?

**Section C**

Questions 41 to 45 carry 4 marks each.

Do these word problems carefully.

Show your working clearly in the space provided for each question.  
(Total: 20 marks)

41. Jaymyn sold 24 buns on Monday. She sold 7 fewer buns on Monday than on Tuesday.

- (a) How many buns did she sell on Tuesday?

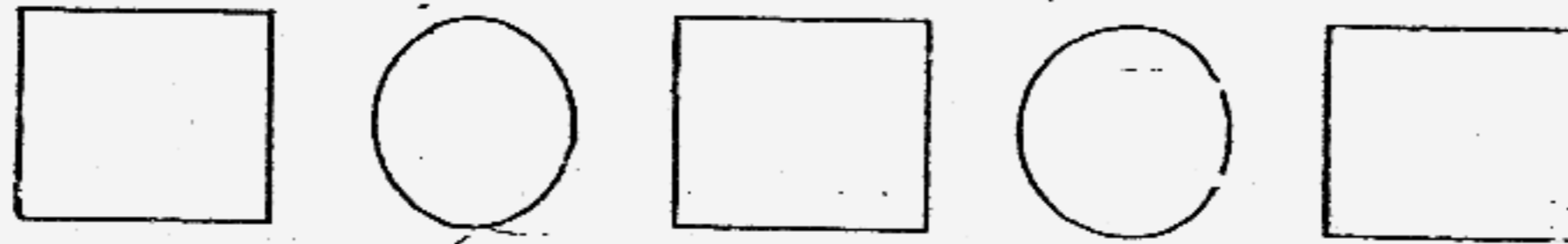

Jaymyn sold \_\_\_\_\_ buns on Tuesday.

- (b) How many buns did she sell on both days?

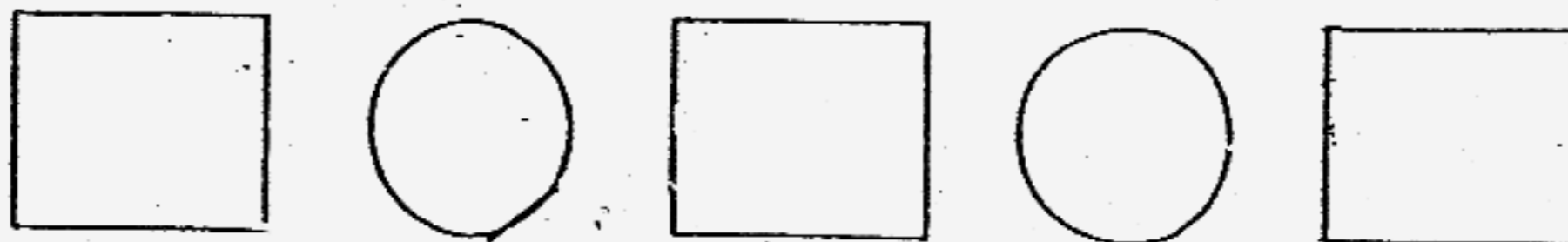

She sold \_\_\_\_\_ buns on both days.

42. Study the figures below.

Each  $\square$  stands for 1 unit.

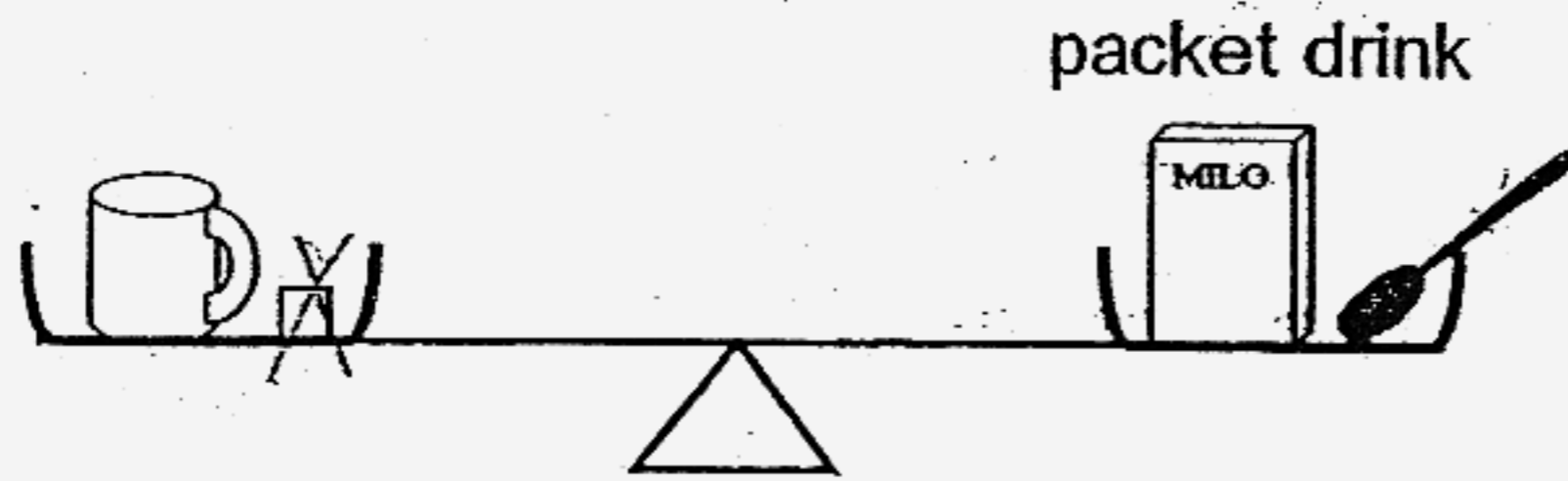
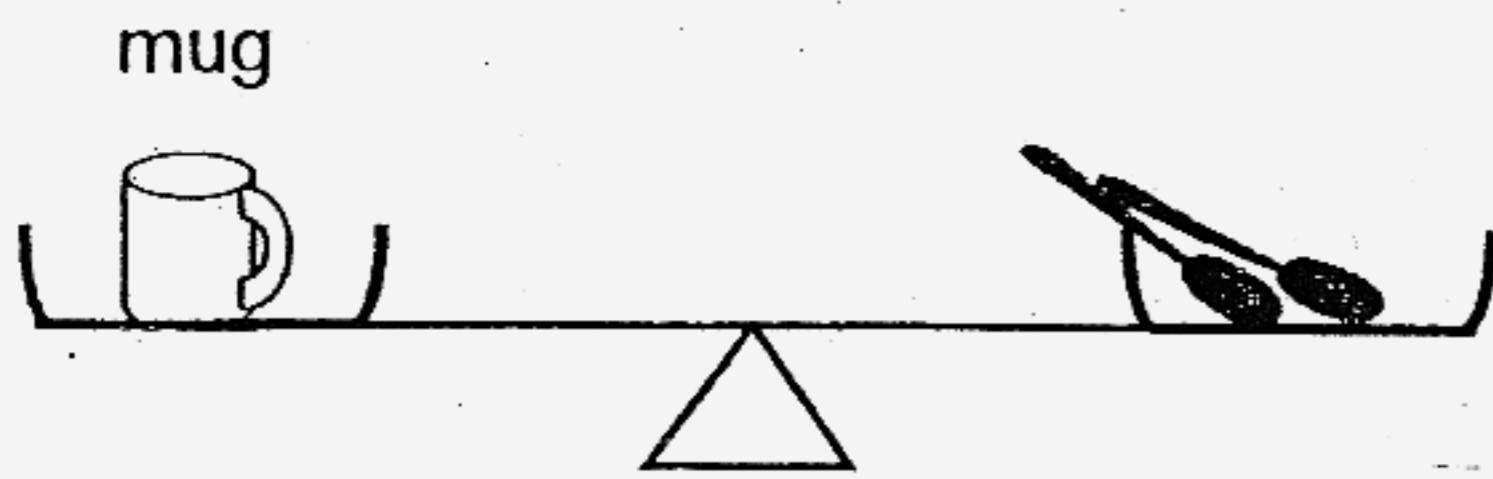
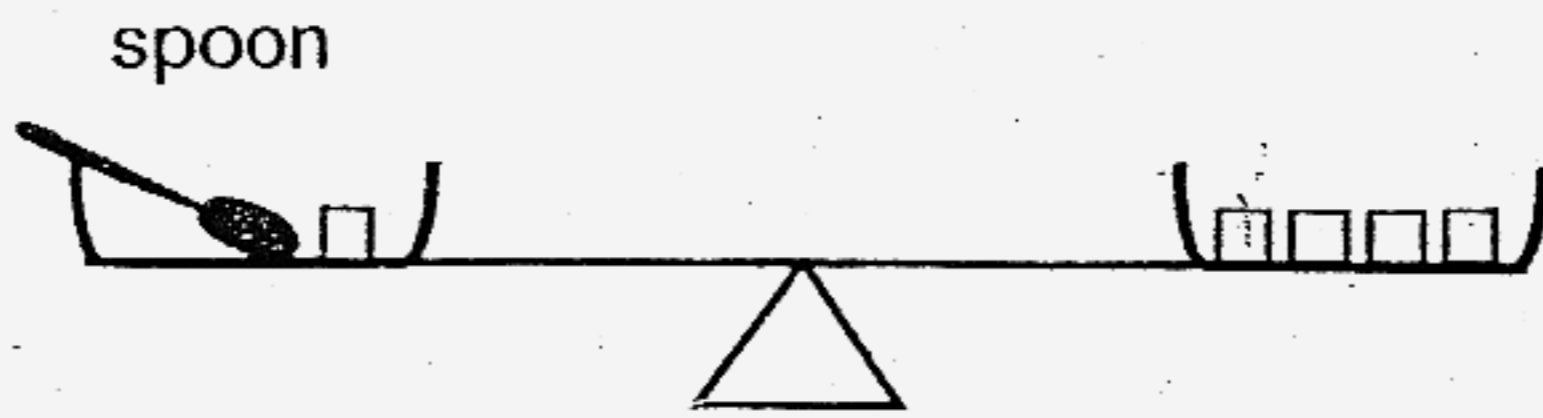

- a) The mass of the spoon is  units.
- b) The mass of the mug is  units.
- c) The mug is heavier than the spoon by  units.
- d) The mass of the packet drink is  units.

43. The table below shows the price of food that Mrs Wang ordered in Jack's restaurant.

Jack's Restaurant	
Item	Amount (\$)
Soup	3
Pork Chop	12
Cake	2
Total	?

- a) How much did Mrs Wang spend altogether?

\$   \$   \$   \$

She spent \$ \_\_\_\_\_ altogether

- b) If Mrs Wang gave the waitress \$60, how much change would she get back?

\$   \$   \$

She would get back \$ \_\_\_\_\_

44. Minah hung 6 pairs of shorts on a clothes line. She used 2 pegs on each pair of shorts.

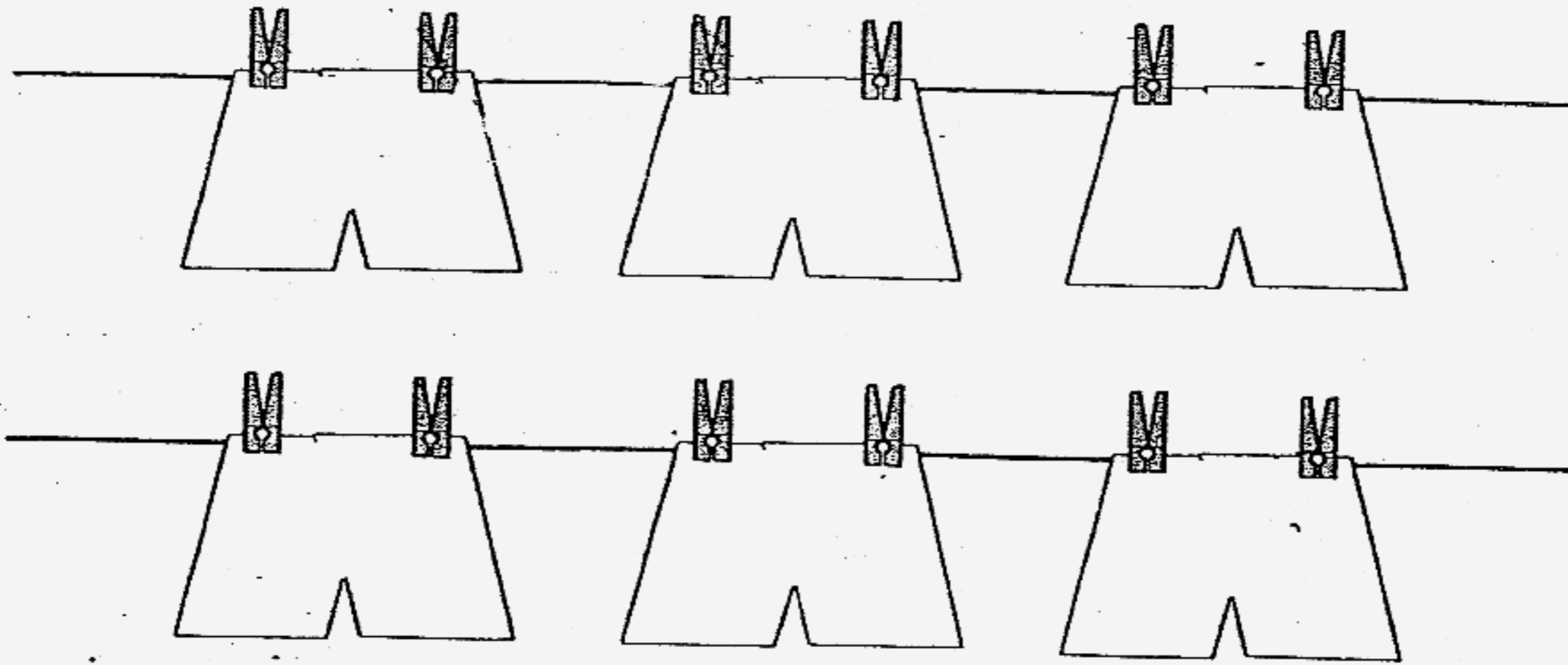

- a) How many pegs did she use altogether?



She used \_\_\_\_\_ pegs altogether.

- b) She broke 3 pegs. How many pegs had she left?

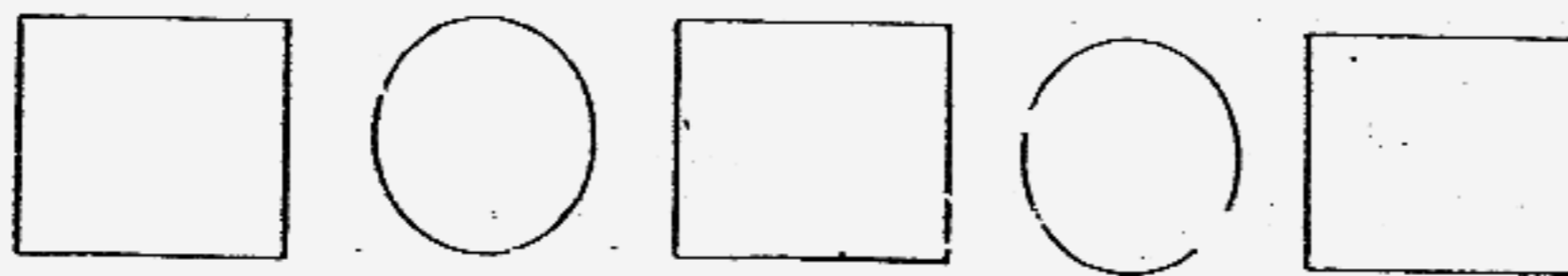

She had \_\_\_\_\_ pegs left.

45. Miss Wong gives out 2 star stickers for every 3 correct answers. Shu Hui has 15 correct answers. How many star stickers does Shu Hui get?

(Hint: Use the table below to solve the question.)

Star Stickers	2				
Correct Answers	3				

Shu Hui gets \_\_\_\_\_ star stickers.

☺ *End of Paper* ☺  
*Please Check Carefully*

Setters: Mrs Sabrina Tan  
Mrs Low Ming Ming

NANYANG PRIMARY SCHOOL - PRIMARY 1 MATHEMATICS 2007  
SEMESTRAL ASSESSMENT (2)

1. 1

2. 4

3. 4

4. 2

5. 1

6. 3

7. 2

8. 3

9. 3

10. 4

11. 2

12. 4

13. 3

14. 4

15. 4

16. 2

17. 1

18. 1

19. 1

20. 3

21. 5

22. 9

23. 17

24.  $9-4=4+1$

25. 16, 11

26. 8

27. P=38 Q=48

28. 6

29. Pen, hammer

30)

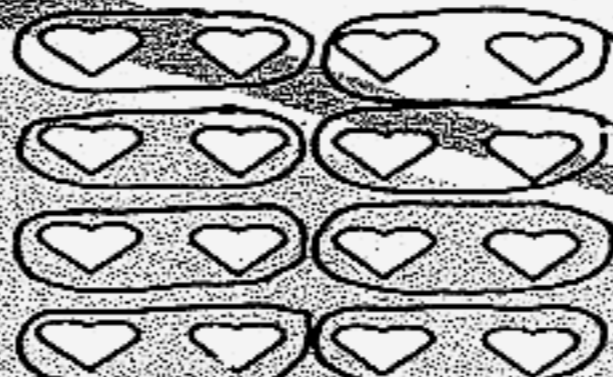

Ans: 2

31)  $3 \times 4 = 12$



Ans: 2

33) 8, 2

34) B

35) Q

36) 15 cents

37) \$10, \$5, \$2, \$2, \$2

38) 7

39) 14

40) Lynn

41) a)  $24+7=31$

Jaymyn sold 31 buns on Tuesday.

b)  $24+31=55$

She sold 55 buns on both days.

42) a) 3

b) 6

c) 3

d) 4

43) a)  $\$3+\$12+\$2=\$17$

She spent \$17 altogether.

b)  $\$60-\$17=\$43$

She would get back \$43.

44) a)  $2 \times 6 = 12$

She used 12 pegs altogether.

b)  $12-3=9$

She had 9 pegs left.

45) 4, 6, 8, 10

6, 9, 12, 15

Shu Hui get 10 star stickers.