

METHODIST GIRLS' SCHOOL (PRIMARY)
PRIMARY SIX MID-YEAR EXAMINATION 2004

MATHEMATICS

S41

BOOKLET A

15 questions

25 marks

Total Time For Booklets A & B : 2 h 15 min

DO NOT OPEN THIS BOOKLET UNTIL YOU ARE TOLD TO DO SO.

FOLLOW ALL INSTRUCTIONS CAREFULLY.

ANSWER ALL THE QUESTIONS.

NAME : _____ ()

CLASS : PRIMARY 6 _____

DATE : _____

SECTION A

Questions 1 to 5 carry 1 mark each. Questions 6 to 15 carry 2 marks each. For each question, four options are given. One of them is the correct answer. Make your choice (1, 2, 3 or 4). Shade the correct oval (1, 2, 3 or 4) on the Optical Answer Sheet.

(25 marks)

1. What is the approximate *length* of an exercise book?

- (1) 8 cm
- (2) 10 cm
- (3) 0.2 m
- (4) 1 m



2. John has 10 five-cent coins, 2 ten-cent coins and 3 fifty-cent coins. How much money does he have?

- (1) \$1.50
- (2) \$1.75
- (3) \$1.80
- (4) \$2.20

3. A laser jet printer can print 9 pages a minute. At this rate, how long will it take to print a document with 108 pages?

- (1) 9 minutes
- (2) 10 minutes
- (3) 11 minutes
- (4) 12 minutes

4. Express 5 cents as a percentage of \$1.

- 1) 1 %
- 2) 5 %
- 3) 10 %
- 4) 50 %

5. Which of the following shapes can tessellate?



~~A~~



B



~~C~~



~~D~~

- 1) B only
- 2) C only
- 3) B and C only
- 4) All of the above

6. What is the missing number in the sequence below?

1, 4, 13, 40, , 364, 1093

- (1) 53
- (2) 58
- (3) 121
- (4) 160

7. Given that String A is $\frac{2}{3}$ of String B and String B is $\frac{6}{5}$ of String C, what fraction of String A is String C?

- (1) $\frac{2}{5}$
- (2) $\frac{1}{2}$
- (3) $\frac{5}{2}$
- (4) $\frac{5}{4}$

8. Abigail bought 2 identical long pants and 3 identical blouses for a total price of \$116. If a pair of pants costs \$8 more than a blouse, how much do 3 pants and 3 blouses cost?

- 1) \$100
- 2) \$120
- 3) \$136
- 4) \$144

9. O is the centre of the circle. If $\frac{1}{6}$ of the figure is shaded, find the perimeter of the part that is not shaded. Correct your answer to the nearest whole number. (Take $\pi = \frac{22}{7}$)

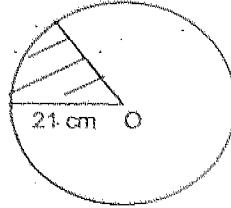

- 1) 110 cm
 2) 152 cm
 3) 180 cm
 4) 1 155 cm
10. Mark can row upstream at a rate of 15m/min. After every 4 minutes of rowing, Mark rested for 3 minutes. At this rate, how long will he take to reach his destination which is 105 m ahead?
- (1) 7 minutes
 (2) 10 minutes
 (3) 15 minutes
 (4) 28 minutes
11. The table below shows the exchange rate between the Singapore dollar and the Malaysian ringgit. Mary went to Genting Highlands in Malaysia and paid RM\$77 for a family package to the Outdoor Theme Park. How much is that in Singapore dollars?

S\$100 = RM\$220

- (1) S\$35.00
 (2) S\$38.50
 (3) S\$77.00
 (4) S\$169.40

12. What is the ratio of the shaded parts to the total number of parts?

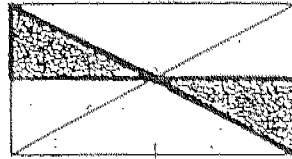

- 1) 2:4
2) 2:5
3) 2:6
4) 2:8
13. The ratio of apples to oranges is 3:4 and the ratio of apples to pears is 5:2. If there are 24 pears, how many oranges are there?
- 1) 60
2) 80
3) 90
4) 180
14. What operations do the symbols * and \diamond stand for in order to make the equation true?

$$a * (a \diamond a) = 2a^2$$

	*	\diamond
1)	X	X
2)	+	+
3)	+	X
4)	X	+

15. The solid shown below is a prism. Which one of the following nets can be folded to form the solid shown below?

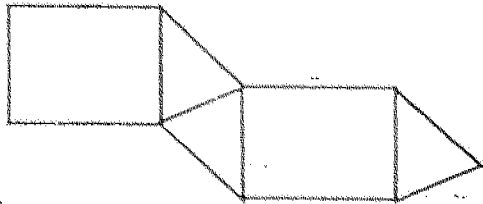
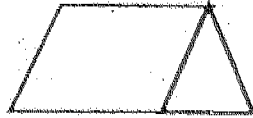

A

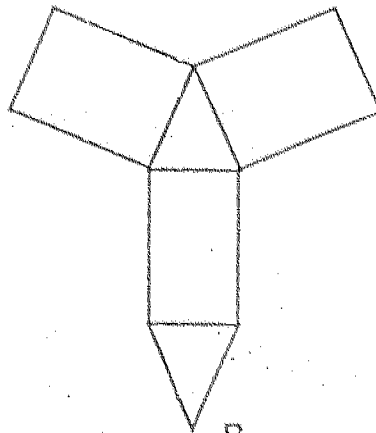

B

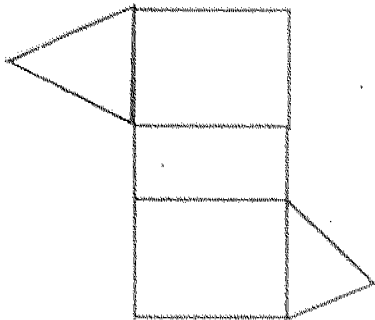

C

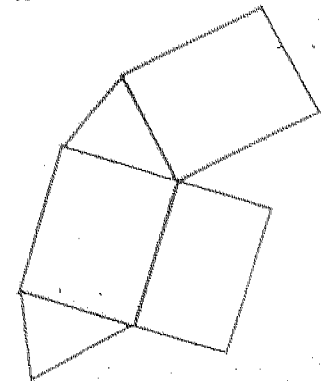

D

- 1) A only
- 2) B only
- 3) A and B only
- 4) All of the above

SECTION B

Questions 16 to 35 carry 1 mark each. Write your answers in the spaces provided. Give your answers in the units stated,

(20 marks)

16. Arrange the following in ascending order from the smallest to the greatest.

$$\frac{7}{9}, \frac{1}{3}, 0.8, \frac{1}{2}$$

Ans: _____

17. Find the value of $3.01 \div 8$. Round off your answer to 2 decimal places.

Ans: _____

18. What is the value of A such that the final result is ¹⁰⁰290?

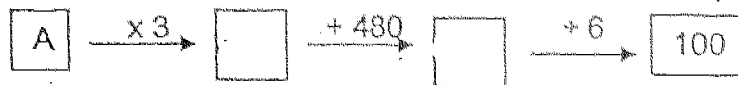

Ans: _____

19. Write down a number which is greater than $\frac{2}{5}$ but less than $\frac{1}{4}$.

Ans: _____

20. Four teams, Blackmore, Jackson, Lee and Olson, played in the Inter-house Basketball Competition. How many games must be played such that each team plays against the other team at least once.

Ans: _____



Ans: _____

22. The radius of a circle is 8 cm. If the radius is increased by 25%, find the area of the circle. (Take $\pi = 3.14$)

Ans: _____ cm^2

23. Michael Schumacher drove a distance of 5 490 m in one and half minutes. Calculate his speed in m/s.

Ans: _____ m/s

24. X and Y are the centres of two circles. If they are 12 cm apart and the radius of the big circle is the same as the diameter of the small circle, find the radius of the big circle.

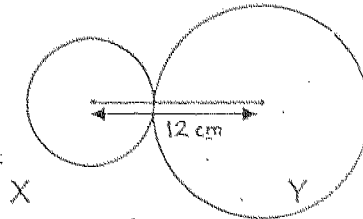

Ans: _____ cm

25. The following is made up of a rectangle and a semicircle. What is the perimeter of the figure? (Take $\pi = \frac{22}{7}$)

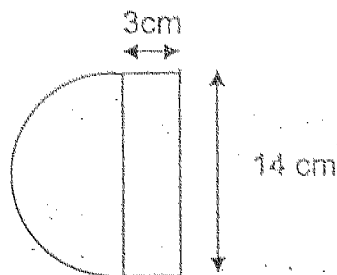

Ans: _____ cm

26. The figure shows 2 squares which overlap. If O is the centre of the bigger square, find the area of the shaded triangle.

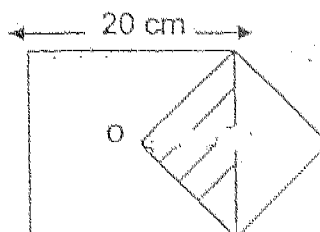

Ans: _____ cm²

27. A telephone company gives its mobile phone subscribers 100 minutes free talktime every month. For every minute used after that, subscribers must pay \$0.15 per minute or part thereof. John talked for 150 minutes over his mobile phone last month. How much did he have to pay?

Ans: \$ _____

28. 450 000 visitors spent approximately \$20 million during the 4-day IT Show. What was the average amount spent by 1 visitor per day? Round off your answer to the nearest dollar.

Ans: \$ _____

29. A train 800m long, enters a tunnel which is 9.3km long at a speed of 100km/h. How long will it take before the end of the train emerges from the tunnel? Round off your answer to the nearest minute.

Ans: _____ min

30. How many lines of symmetry does the figure have?

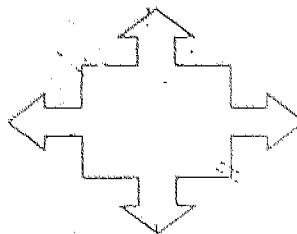

Ans: _____

31. Simplify the following algebraic expression:

$$15p + 3p \times 2p - p$$

Ans: _____

32. A rectangular plot of land measuring $4b$ metres by 3 metres has a pond with an area of $b \text{ m}^2$ in it. What is the area of the shaded region?

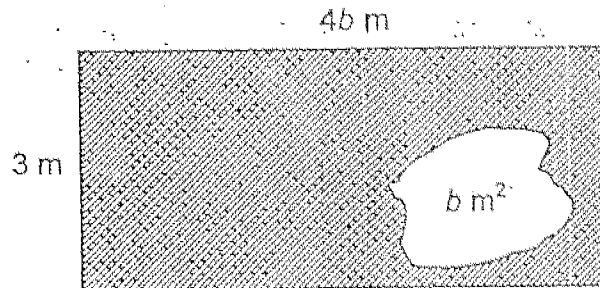

Ans: _____ m^2

33. Using the unit shape given, draw two more such shapes to make a tessellation in the space provided.

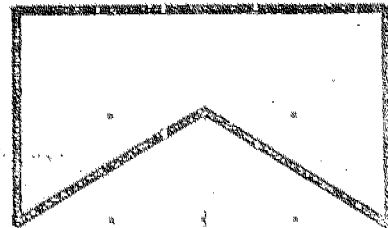

34. Mrs Tan's age is $2\frac{1}{2}$ times her daughter's age. The ratio of her daughter's age to Mrs Tan's age is _____.

Ans: _____

35. One bowl of noodles was sold for \$ 2.50, what was the total amount collected from 90 bowls?

Ans: \$ _____

SECTION B2

For questions 36 to 50, show your working clearly in the space provided below each question and write your answers in the spaces provided.

The number of marks available is shown in brackets [] at the end of each question or part-question.

(55 marks)

36. Caleb started his trip from city A. He went east for 15 km, then went north for another 3 km. After that, he went west for 9 km. Finally, he went north for another 6 km, ending his trip at city B. If he can only go north, south, east or west, what is the shortest distance between city A to city B?

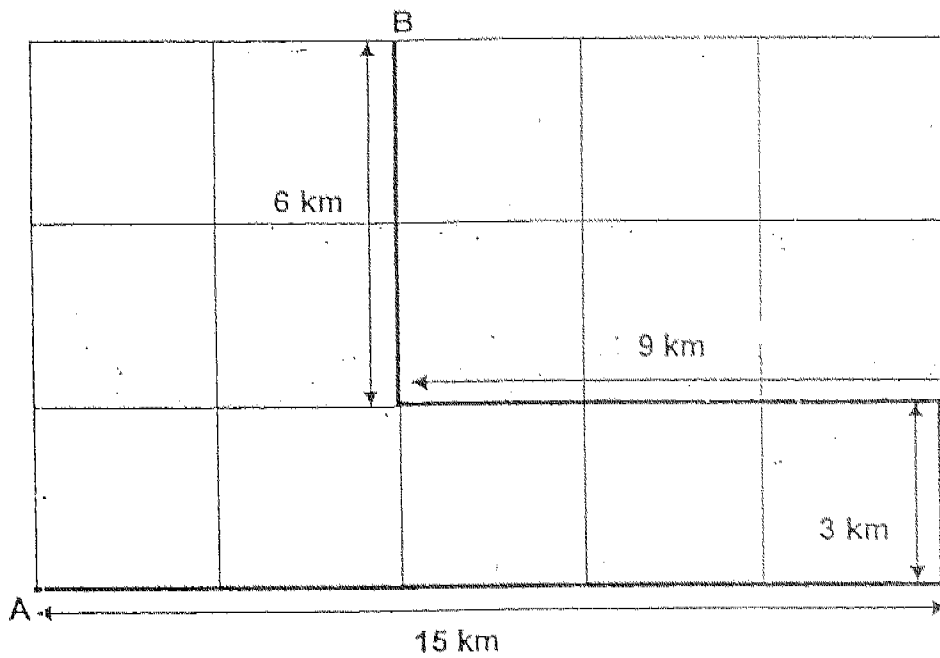

Ans: _____ [2m]

37. Jenny has an equal number of 5-cent coins and 20-cent coins. If the total number of coins she has is 48, how much does Jenny have?

Ans: _____ [2m]

38. Sarah has \$2. She can either buy 2 pens and 8 erasers or just 6 pens. How many erasers can she buy with \$6?

Ans: _____ [2m]

39. The figure shows two squares of side 5 cm and 3 cm respectively. Find the area of the shaded region.

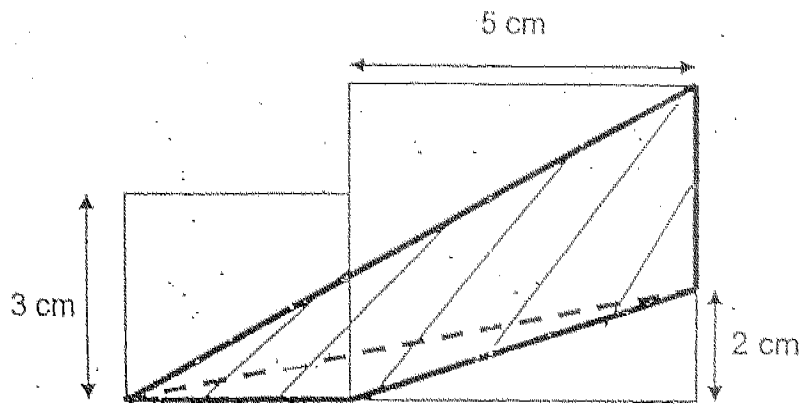

Ans: _____ [3m]

40. The average score of a mathematics test in a class is 5.2. One student, who scored 7 in the test, transferred to another school. As a result, the average score of the remaining students was 5. How many students were there at first?

Ans: _____ [3m]

41. Two nets of the same cube are shown. Fill in the 3 blanks of the net on the right.

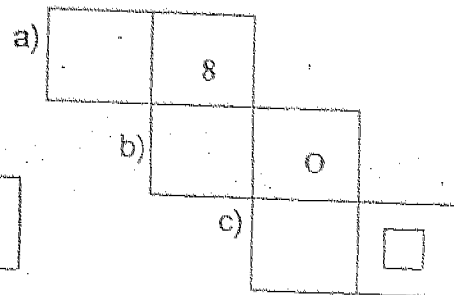
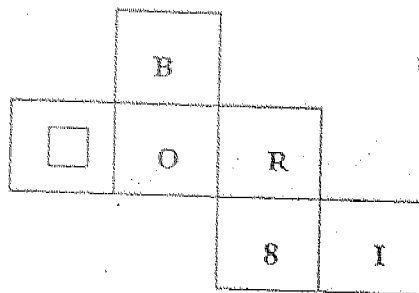

Ans: a) _____ [1m]

b) _____ [1m]

c) _____ [1m]

42. Mrs Ang paid \$ m for a plant after she was given a 20% discount. What was the original cost of the plant?

Ans: _____ [4m]

43. The ratio of Mr Lim's salary to that of his wife's is 5:4. Each of them saves \$1 690 and spends the rest of their money. The ratio of the amount of money Mr Lim spent to the amount that his wife spent is 12:7.
- (a) What is Mr Lim's salary?
(b) What is his wife's salary?

Ans: a) _____ [3m]

b) _____ [1m]

44. Study the pattern below:

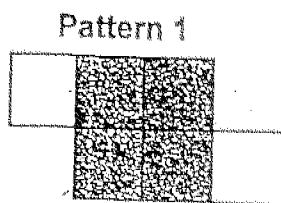

1 square of 4

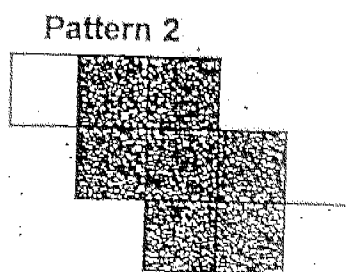

2 squares of 4

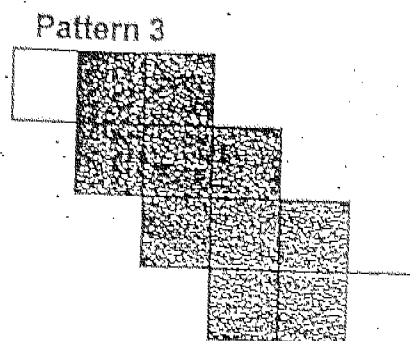

3 squares of 4

- (a) To make 1 square of 4, 4 tiles are needed. To make 2 squares of 4, 7 tiles are needed. How many tiles are needed to make 7 squares of 4?
- (b) How many tiles are there in the 25th pattern?

Ans: a) _____ [2m]

b) / _____ [2m]

45. The Swiss Ferryboat is full when it has 10 cars on board. It is also full when it has 6 trucks on board. The ferryboat never carries cars and trucks at the same time. The ferryboat made thirteen trips across the river and was full on each trip. It carried a total of 98 cars and trucks across the river.
- (a) How many cars did the ferryboat carry altogether in the thirteen trips?
 - (b) How many trucks did the ferryboat carry altogether in the thirteen trips?

Ans: a) _____ [2m]

b) _____ [2m]

46. Alan, Bob and Carl ran at a speed of 5 km/h, 6 km/h and 7 km/h respectively. They ran along the same route and started at 6.00 a.m., 6.30 a.m. and 7.00 a.m. respectively. When Bob passed Alan, he gave Alan a message to pass to Carl. What time will Carl receive the message?

Ans: _____ [4m]

47. In January, the sale of red pens was \$ 4 550. This was 25% more than the sale in February. In March, the sale was 16% less than the sale in January. Find the average sale of red pens for the 3 months.

Ans: _____ [5m]

48. The figure shows two quadrants and a rectangle. The radius of the big quadrant is 8 cm. The radius of the small quadrant is 4 cm. Find the difference in area between the two shaded parts A and B. (Take $\pi = 3.14$)

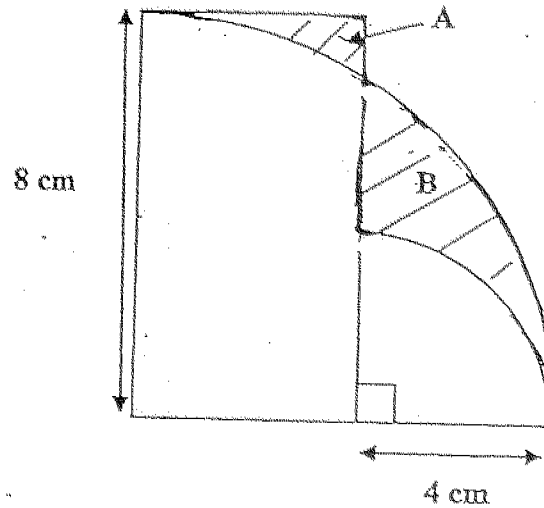

Ans: _____ [5m]

49. Wei Ling has some dollar notes in her wallet. $\frac{3}{7}$ of them are \$10 notes. $\frac{2}{3}$ of the remainder are \$5 notes and the rest are \$1 notes. If she has 12 \$1 notes, how much money does Wei Ling have in her wallet?

Ans: _____ [5m]

50. Gary can pack a certain number of bottles in 3 hours while Elizabeth can pack the same number of bottles in 4 hours. Both of them work together for 5 hours

- (a) How many bottles did Elizabeth pack if Gary packed 200 bottles?
- (b) How many more hours should both of them work if they need to pack another 140 bottles?

Ans: (a) _____ [3m]

(b) _____ [2m]

METHODIST GIRLS SCHOOL (PRIMARY)
 PRIMARY SIX MID-YEAR EXAMINATION 2004
 MATHEMATICS

SM

- | | | |
|------------------------------|---------------------------|--------------------------|
| 1) 3 | 27) 7.50 | 46) 0.30 a.m. |
| 2) 4 | 28) 11 | 47) \$ 4004 |
| 3) 4 | 29) 6 min | 48) 5.68 cm ³ |
| 4) 2 | 30) 2 lines | 49) \$ 402 |
| 5) 3 | 31) 14p + 6p ² | 50) a) 150 bottles |
| 6) 3 | 32) 11b m ² | b) 2 hours |
| 7) 4 | 33) | |
| 8) 4 | 34) 2 : 5 | |
| 9) 2 | 35) 225 | |
| 10) 2 | 36) 15 km | |
| 11) 1 | 37) \$ 6 | |
| 12) 4 | 38) 36 erasers | |
| 13) 2 | 39) 15 cm ² | |
| 14) 4 | 40) 10 students | |
| 15) 2 | 41) a) I | |
| 16) 1/3 1/2 7/9 0.8 | b) R | |
| 17) 0.38 | c) B | |
| 18) 40 | 42) \$ ($\frac{5m}{4}$) | |
| 19) 9/40 | 43) a) \$ 3250 | |
| 20) 6 games | b) \$ 2600 | |
| 21) 0.38 | 44) a) 22 tiles | |
| 22) 314 | b) 76 tiles | |
| 23) 61 | 45) a) 50 cars | |
| 24) 8 | b) 48 trucks | |
| 25) 42 | | |
| 26) 100 | | |